

INTERNAL TOOLHOLDERS SET

For internal turning



INTERNAL
TOOLHOLDERS SET









NEW



SINCE 1916

INTERNAL TOOLHOLDERS SET

Conjuntos de ferramentas de torneamento interno | Grupos de herramientas de torneado interno

Finishing	Finishing	Finishing	Finishing	Finishing	Finishing wiper	Medium to Finishing
Flat  (06)	FP  (06)	BO  (06)	FM  (06)	FK  (06)	FW  (06)	LM  (06)
Medium	Medium	Medium	Medium to Finishing wiper	Finishing to Fine finishing	Medium to Finishing	
MP  (06)	MM  (06)	MK  (06)	MW  (06)	FS  (06)	LN  (06)	

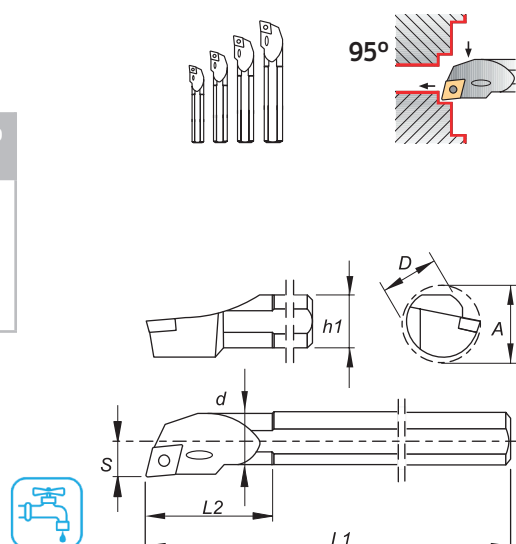



Order Code		Reference	Dimensions (mm)							Insert	Kg	Stock	
R Pack	R		D	d	L1	L2	S	A	h1			Pack	R
212359300	212250500	A0608H SCLC R 06	8	6	100	25	4	10	7	CC.. 0602..	0,400	⊗	⊗
	212359400	A0810J SCLC R 06	10	8	110	32	6	12	9	CC.. 0602..			⊗
	212250600	A1012K SCLC R 06	12	10	125	38	7	14	11	CC.. 0602..			⊗
	212167900	A1216M SCLC R 06	16	12	150	50	9	18	15	CC.. 0602..			⊗

Order Code		Reference	Dimensions (mm)							Insert	Kg	Stock	
L Pack	L		D	d	L1	L2	S	A	L1			Pack	L
212359500	212359600	A0608H SCLC L 06	8	6	100	25	4	10	7	CC.. 0602..	0,400	⊗	⊗
	212359700	A0810J SCLC L 06	10	8	110	32	6	12	9	CC.. 0602..			⊗
	212359800	A1012K SCLC L 06	12	10	125	38	7	14	11	CC.. 0602..			⊗
	212359900	A1216M SCLC L 06	16	12	150	50	9	18	15	CC.. 0602..			⊗

⊗ Stock items | Itens de stock

○ Available under request | Disponível sob consulta | Disponible bajo consulta

SPARE PARTS || Complementos | Repuestos









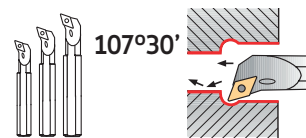

Cutter Reference	Screw	Wrench
A0608H SCLC R/L 06	 P0200601	 XT07
A0810J SCLC R/L 06	P0200601	XT07
A1012K SCLC R/L 06	P0250700	XT07
A1216M SCLC R/L 06	P0250700	XT07

PK SDQC 107°30' || TOOLHOLDERS | Ferros de torno | Herramientas de torneado

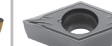



INTERNAL TOOLHOLDERS SET



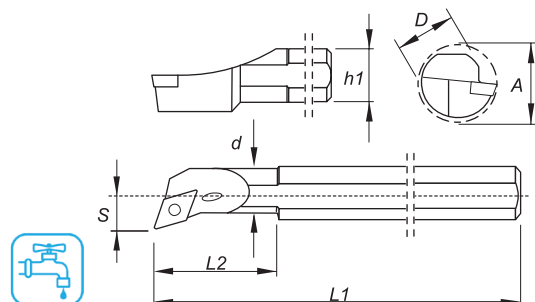

Conjuntos de ferramentas de torneamento interno | Grupos de herramientas de torneado interno



Finishing	Finishing	Finishing	Finishing	Finishing wiper	Medium to Finishing
Flat	FP	FM	FK	FW	LM
 (07)	 (07)	 (07)	 (07)	 (07)	 (07)
Medium	Medium	Medium	Finishing to Fine Finishing	Finishing to Fine Finishing	
MP	MM	MK	FS	LN	
 (07)	 (07)	 (07)	 (07)	 (07)	



Order Code		Reference	Dimensions (mm)							Insert	Kg	Stock	
R Pack	R		D	d	L1	L2	S	A	h1			Pack	R
212360000	212360100	A0810J SDQC R 07	10	8	110	32	7	12,5	9	DC.. 0702..	0,350		
	212360200	A1012K SDQC R 07	12	10	125	38	9	15,5	11	DC.. 0702..			
	212360300	A1216M SDQC R 07	16	12	150	50	11	19,5	15	DC.. 0702..			

Order Code		Reference	Dimensions (mm)							Insert	Kg	Stock	
L Pack	L		D	d	L1	L2	S	A	L1			Pack	L
212360400	212360500	A0810J SDQC L 07	10	8	110	32	7	12,5	9	DC.. 0702..	0,350		
	212360600	A1012K SDQC L 07	12	10	125	38	9	15,5	11	DC.. 0702..			
	212360700	A1216M SDQC L 07	16	12	150	50	11	19,5	15	DC.. 0702..			

 Stock Items | Itens de stock





 Available under request | Disponível sob consulta | Disponible bajo consulta

SPARE PARTS || Complementos | Repuestos



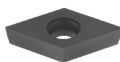
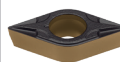

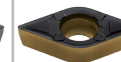
Cutter Reference	Screw	Wrench
		
A0810J SDQC R/L 07	P0200601	XT07
A1012K SDQC R/L 07	P0250700	XT07
A1216M SDQC R/L 07	P0250700	XT07

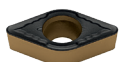
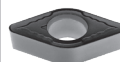
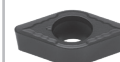
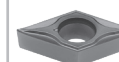
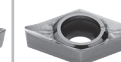

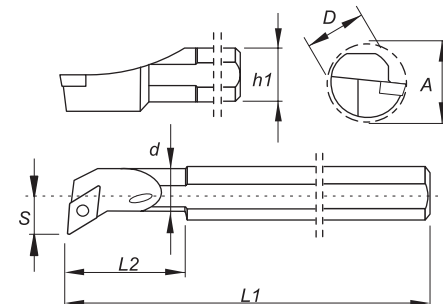
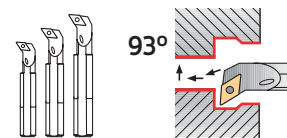

INTERNAL TOOLHOLDERS SET

Conjuntos de ferramentas de torneamento interno | Grupos de herramientas de torneado interno

Finishing	Finishing	Finishing	Finishing	Finishing wiper	Medium to Finishing
Flat	FP	FM	FK	FW	LM
 (07)	 (07)	 (07)	 (07)	 (07)	 (07)
Medium	Medium	Medium	Finishing to Fine Finishing	Finishing to Fine Finishing	
MP	MM	MK	FS	LN	
 (07)	 (07)	 (07)	 (07)	 (07)	





Order Code		Reference	Dimensions (mm)							Insert	Kg	Stock	
R Pack	R		D	d	L1	L2	S	A	h1			Pack	R
212360800	212360900	A0810J SDUC R 07	10	8	110	32	7	12,5	9	DC.. 0702..	0,350		
	212361000	A1012K SDUC R 07	12	10	125	38	9	15,5	11	DC.. 0702..			
	212361100	A1216M SDUC R 07	16	12	150	50	11	19,5	15	DC.. 0702..			

Order Code		Reference	Dimensions (mm)							Insert	Kg	Stock	
L Pack	L		D	d	L1	L2	S	A	L1			Pack	L
212361200	212361300	A0810J SDUC L 07	10	8	110	32	7	12,5	9	DC.. 0702..	0,350		
	212361400	A1012K SDUC L 07	12	10	125	38	9	15,5	11	DC.. 0702..			
	212361500	A1216M SDUC L 07	16	12	150	50	11	19,5	15	DC.. 0702..			

 Stock Items | Itens de stock

 Available under request | Disponível sob consulta | Disponible bajo consulta

SPARE PARTS || Complementos | Repuestos

Cutter Reference	Screw	Wrench
		
A0810J SDUC R/L 07	P0200601	XT07
A1012K SDUC R/L 07	P0250700	XT07
A1216M SDUC R/L 07	P0250700	XT07

INTERNAL TOOLHOLDERS SET

Conjuntos de ferramentas de torneamento interno | Grupos de herramientas de torneado interno

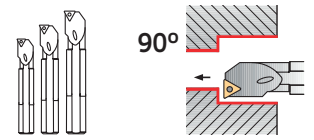

Finishing	Finishing	Finishing	Finishing
Flat  (11)	FP  (11)	FM  (11)	FK  (11)
Medium	Medium	Medium	Medium to Finishing
MP  (11)	MM  (11)	MK  (11)	LN  (11)

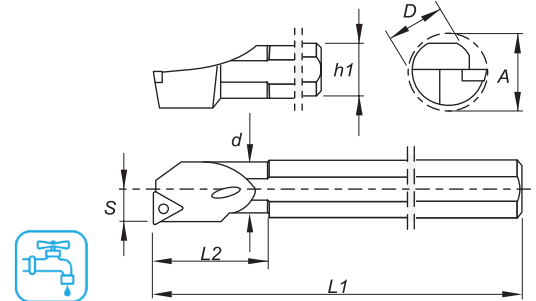



Order Code		Reference	Dimensions (mm)							Insert	Kg	Stock	
R Pack	R		D	d	L1	L2	S	A	h1			Pack	R
212361600	212361700	A0810J STFC R 11	10	8	110	32	7	12,5	9	TC.. 1102..	0,350	⊗	⊗
	212361800	A1012K STFC R 11	12	10	125	38	9	15,5	11	TC.. 1102..			⊗
	212361900	A1216M STFC R 11	16	12	150	50	11	19,5	15	TC.. 1102..			⊗

Order Code		Reference	Dimensions (mm)							Insert	Kg	Stock	
L Pack	L		D	d	L1	L2	S	A	L1			Pack	L
212362000	212362100	A0810J STFC L 11	10	8	110	32	7	12,5	9	TC.. 1102..	0,350	⊗	⊗
	212362200	A1012K STFC L 11	12	10	125	38	9	15,5	11	TC.. 1102..			⊗
	212362300	A1216M STFC L 11	16	12	150	50	11	19,5	15	TC.. 1102..			⊗

⊗ Stock Items | Itens de stock

○ Available under request | Disponível sob consulta | Disponible bajo consulta

SPARE PARTS | Complementos | Repuestos

Cutter Reference	Screw	Wrench
		
A0810J STFC R/L 11	P0200601	XT07
A1012K STFC R/L 11	P0250700	XT07
A1216M STFC R/L 11	P0250700	XT07



INTERNAL
TOOLHOLDERS SET

NEW

HEADQUARTERS

PALBIT. S.A.

P.O.Box 4 - Palhal

3854-908 - Branca ALB - Portugal

T (+351) 234 540 300 | F (+351) 234 540 301

palbit@palbit.pt | www.palbit.pt

Branch office:

PALBIT México

Emerson 150. Int.803-804. Colonia Chapultepec

Morales Delagación Miguel Hidalgo

C.P. 11570 México DF

T (+52) 5555 454 543 | F (+52) 5552 509 190

info@palbit.com.mx | www.palbit.com.mx



SINCE 1916