

DYN-INTEG

HR38TSM

Trochoidal milling for stainless steels and super alloys

MILLING
Solid Carbide



DYN INTEG Trochoidal milling

Discover the new solid carbide end mill, HR38TSM, engineered specifically for trochoidal milling on stainless steels and superalloys, which also performs well on steels.

This innovative tool optimizes high feed rates with low radial engagement and high axial depth, leading to impressive material removal rates and cycle time reductions in challenging materials. In addition, this machining method facilitates consistent and gradual wear across the entire cutting edge, which contributes to a longer tool lifespan.

Features & Benefits

- Optimized five-flute geometry for high efficiency milling on stainless steels and super alloys;
- Unequal flute spacing provides vibration-free operations and improved tool life;
- Improvement in process reliability;
- Single tool for both roughing and finishing operations;
- Available in two cutting lengths: 2xDC and 3xDC;
- Ramping capability up to 3°;
- New high-performance coating, PHF, for increased wear resistance.

Operations

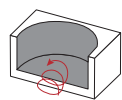

Trochoidal Milling

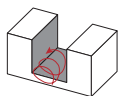

Trochoidal Slotting (2xDC | 3xDC)

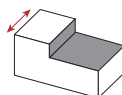

Shouldering

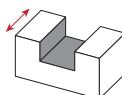

Slotting (1xDC)

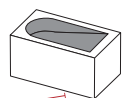

Ramp Down

Variable Pitch Angle

Ensures smooth and stable cutting, reducing vibrations and improving surface finish.

Shank Type

With cylindrical or weldon shank for improved balance during machining.

Conical Core

Provides an increased tool robustness for higher cutting depths.

High Performance Coating

PHF provides excellent thermal stability.

Optimized Flute Geometry

For trochoidal milling operations.

Front Cutting Edge Cavity

Allow ramp down milling.

Corner Radius

Minimize edge chipping and extending tool life ensuring precision and reliability.

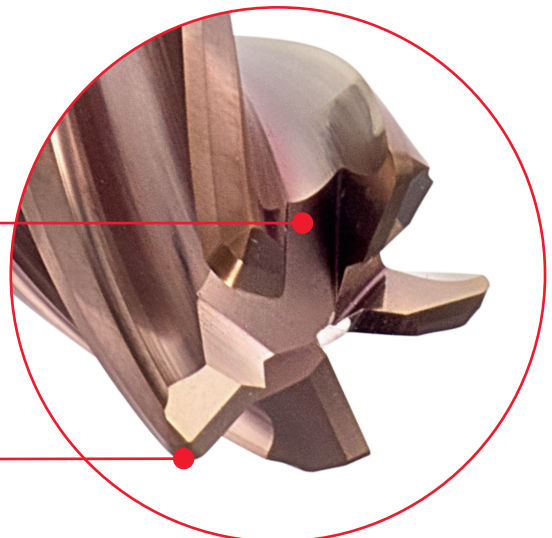
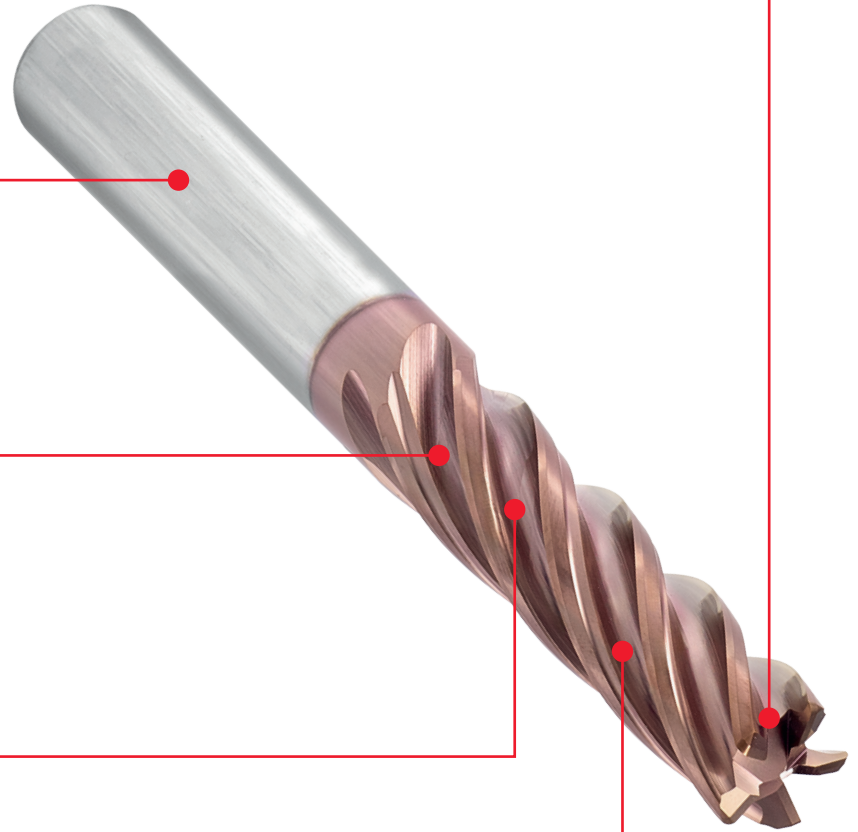

DYN INTEG Trochoidal milling

Trochoidal milling is a highly efficient machining strategy that combines circular and linear motion to optimize material removal while reducing cutting forces, particularly in challenging materials and complex geometries. This method uses a small cutting width (a_e) and a high cutting depth (a_p) to fully engage the tool's entire cutting edge, distributing wear evenly and extending tool life.

Trochoidal milling strategy

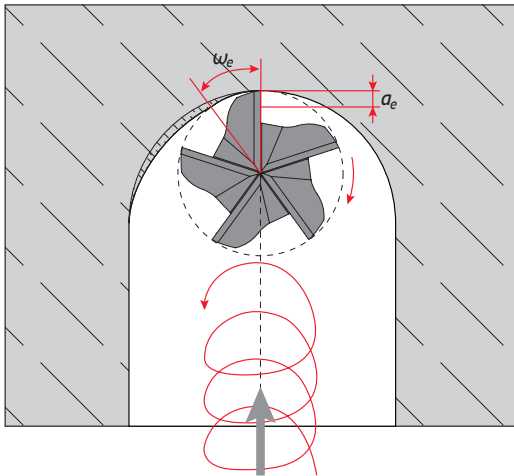

This milling strategy is based on a toolpath that optimizes tool engagement with the material, often varying the width (a_e) of the cut dynamically. The CAM software fixes the tool engagement angle (ω_e) in the workpiece, maintaining a constant chip thickness. This results in lower vibrations, reduced cutting forces, increased tool life, and improved surface quality.

One of the primary benefits of this approach is the ability to achieve higher material removal rates by optimizing the tool path and minimizing tool contact with the material. This leads to faster cutting speeds and shorter cycle times.

The HR38TSM end mill can cut depths up to three times its diameter in a single pass, allowing for deeper cuts without the issues commonly associated with conventional milling, such as excessive heat, vibration, tool deflection, and chip recutting.

The intermittent cutting action in trochoidal milling reduces heat generation and cutting forces, extending tool life. Additionally, the dynamic tool path improves chip evacuation, preventing chip-related issues that can affect surface quality. This method also produces smoother surface finishes due to reduced vibrations during the machining process.

Moreover, trochoidal milling achieves high material removal rates even on machines with lower power capacities. This technique is also cost-effective, as it enables the same tool to create larger diameters than its cutting diameter, allowing it to cut various hole sizes and reducing the need for multiple tools, which helps lower production costs.

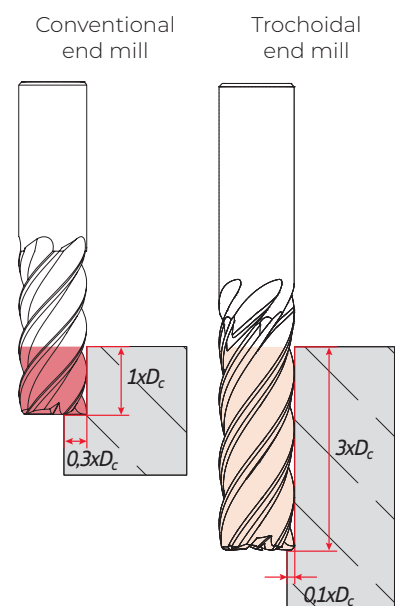

TOOL ENGAGEMENT ANGLE - Conventional vs Trochoidal

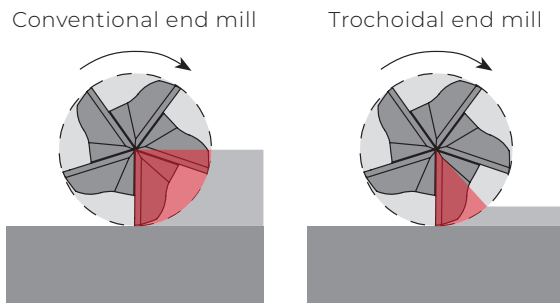

■ ω_e - engagement angle

In climb milling, where the chip thickness is greater at the beginning of the cut and smaller at the end, using a lower tool engagement angle (ω_e) results in a chip thinning effect. Since the thickness of the produced chips is smaller than what was originally programmed. This effect facilitates the chips evacuation.

The smaller the stepover (a_e), the smaller the tool engagement angle (ω_e) becomes.

If we keep the tool engagement angle (ω_e) constant throughout the machining process, the thickness of the chips will also remain constant. However, if the stepover (a_e) is constant, the chip thickness will vary with the geometry of the workpiece.

CONVENTIONAL END MILL VS TROCHOIDAL END MILL

To better understand the differences between conventional and trochoidal milling tools, explore the table below to learn how you can maximize your production.:

	Conventional End mill	Trochoidal End mill
Toolpath	Follows a linear cutting path with higher radial engagement, concentrating stress on specific areas of the tool, which can lead to faster wear	Uses a dynamic toolpath with low cutting width (a_e) and high depth of cut (a_p), which distributes wear evenly across the entire cutting edge
Cutting Forces	Higher radial engagement generates greater cutting forces, leading to increased tool wear	Lower radial engagement reduces cutting forces, which decreases tool wear
Material Removal Rate	Despite high radial engagement, this approach requires multiple passes at shallower depths and low feed rates, resulting in lower material removal rate	Achieves high material removal rates due to high feed rates with higher depths of cut, making it more efficient for large volumes of material
Heat Generation	Higher radial engagement generates more heat	Produces less heat as a result of smaller engagement and the effect of chip thinning
Tool Life	Shorter tool life as wear is concentrated on specific areas of the tool	Longer tool life due to balanced wear distribution and better heat management
Applications	More commonly used in less demanding applications or simpler geometries where high efficiency or tool longevity are less critical	Best suited for high-efficiency milling in hard materials or complex geometries, where precision and tool longevity are essential
Cost efficiency	Lower upfront cost, but can become less cost-effective over time due to more frequent tool replacements and longer cycle times	Although the initial tool cost is higher, operational costs are lower due to longer tool life, faster machining, and fewer tool changes.

In summary, trochoidal end mills offer superior performance in terms of tool life, efficiency, and reliability for demanding machining applications, while conventional end mills are better suited for simpler tasks.

HR38TSM Corner radius



M S

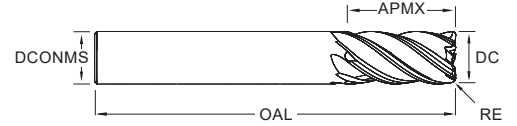

⁽¹⁾ Order code		⁽²⁾ Grade code		4F	Dimensions Dimensões Dimensiones (mm)				
		Reference Referência Referencia	NOF		PHF910	DC	DCONMS	APMX	RE
HA (Cylindrical)	HB (Weldon)								
HR38TSMS									
1182476	1182501	HR38TSMS 5 060 12 R100	5	○	6	6	12	1,00	57
1182477	1182502	HR38TSMS 5 060 12 R050	5	⊗	6	6	12	0,50	57
1182478	1182503	HR38TSMS 5 080 16 R100	5	○	8	8	16	1,00	63
1182479	1182504	HR38TSMS 5 080 16 R050	5	⊗	8	8	16	0,50	63
1182480	1182505	HR38TSMS 5 100 20 R100	5	⊗	10	10	20	1,00	72
1182481	1182506	HR38TSMS 5 100 20 R050	5	○	10	10	20	0,50	72
1182332	1182507	HR38TSMS 5 120 24 R100	5	⊗	12	12	24	1,00	83
1182482	1182508	HR38TSMS 5 120 24 R050	5	○	12	12	24	0,50	83
1182331	1182509	HR38TSMS 5 160 32 R100	5	⊗	16	16	32	1,00	92
1182483	1182510	HR38TSMS 5 160 32 R200	5	○	16	16	32	2,00	92
1182484	1182511	HR38TSMS 5 180 36 R100	5	○	18	18	36	1,00	92
1182485	1182512	HR38TSMS 5 180 36 R200	5	○	18	18	36	2,00	92
1182486	1182513	HR38TSMS 5 200 40 R100	5	○	20	20	40	1,00	104
1182487	1182514	HR38TSMS 5 200 40 R200	5	○	20	20	40	2,00	104
HR38TSML									
1182488	1182515	HR38TSML 5 060 18 R100	5	○	6	6	18	1,00	57
1182489	1182516	HR38TSML 5 060 18 R050	5	⊗	6	6	18	0,50	57
1182490	1182517	HR38TSML 5 080 24 R100	5	○	8	8	24	1,00	63
1182491	1182518	HR38TSML 5 080 24 R050	5	⊗	8	8	24	0,50	63
1182492	1182519	HR38TSML 5 100 30 R100	5	⊗	10	10	30	1,00	72
1182493	1182520	HR38TSML 5 100 30 R050	5	⊗	10	10	30	0,50	72
1182494	1182521	HR38TSML 5 120 36 R100	5	⊗	12	12	36	1,00	83
1182495	1182522	HR38TSML 5 120 36 R050	5	⊗	12	12	36	0,50	83
1182390	1182523	HR38TSML 5 160 48 R100	5	⊗	16	16	48	1,00	100
1182496	1182524	HR38TSML 5 160 48 R200	5	○	16	16	48	2,00	100
1182497	1182525	HR38TSML 5 180 54 R100	5	○	18	18	54	1,00	104
1182498	1182526	HR38TSML 5 180 54 R200	5	○	18	18	54	2,00	104
1182499	1182527	HR38TSML 5 200 60 R100	5	○	20	20	60	1,00	110
1182500	1182528	HR38TSML 5 200 60 R200	5	○	20	20	60	2,00	110

⊗ Stock item | Produto de stock | Itens de stock ○ Available under request | Disponível sobre consulta | Disponible bajo consulta

End mill order code = (1) Geometry Code + (2) Grade Code

Note: For HB (Weldon) end mills, the reference ends with "-W"

Example: "HR38TSMS 5 080 16 R100-W"

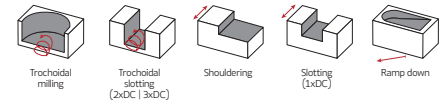

RECOMMENDED CUTTING CONDITIONS Condições de corte recomendadas | Condiciones de corte recomendables

ISO	Workpiece Material	HB	ap	ae / DC = 5%		ae / DC = 10%		ae / DC = 15%		Coolant	
				Vc (m/min)	fz (mm/t)	Vc (m/min)	fz (mm/t)	Vc (m/min)	fz (mm/t)	Air	Emulsion
P	Unalloyed Steel	125-220	2 x DC 3 x DC	290-390	0,015 x DC	190-280	0,011 x DC	170-250	0,010 x DC	☉	○
	Low-Alloyed Steel	220-280		255-390	0,014 x DC	165-250	0,010 x DC	150-225	0,009 x DC	☉	○
	High-Alloyed Steel	280-380		145-260	0,011 x DC	95-170	0,008 x DC	85-150	0,007 x DC	☉	○
M	SS - Ferritic / Martensitic	200-330		190-260	0,013 x DC	125-170	0,009 x DC	110-150	0,008 x DC		☉
	SS - Austenitic	200-330		120-190	0,010 x DC	80-125	0,008 x DC	70-110	0,007 x DC		☉
	SS - Austenitic-ferritic (Duplex)	230-260		120-170	0,009 x DC	80-110	0,006 x DC	70-100	0,005 x DC		☉
S	Heat Resistant Super Alloys	200-320		85-155	0,007 x DC	55-100	0,005 x DC	50-90	0,004 x DC		☉

Note: - The cutting conditions for ae/DC = 100% are obtained by multiplying the cutting conditions for ae/DC = 10% by the following coefficients: ☉ Recommended ○ Second choice

ae/DC	100%
Vc	0,65 x Vc10%
fz	0,60 x fz10%
ap	1 x DC

Note: - For operations with ae/DC > 15%, we recommend only the shorter version - HR38TSMS
- Cutting speed (Vc) adjusts: lower for high stock removal/hard materials, higher for finishing/soft materials.

stepover (ae)	2%	5%	7,5%	10%	15%	20%	30%	40%	50%	100%
engagement angle (we)	16,26°	25,84°	31,79°	36,87°	45,57°	53,13°	66,42°	78,46°	90°	180°

TEST REPORT Relatório de Teste | Informe de Prueba

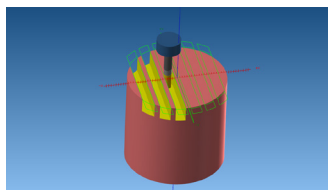

Workpiece Material: X 5 CrNiMo 17-12-2 (316L)

Operation: Trochoidal Slotting

Coolant: Emulsion

Workpiece CAM program

End mill	HR38TSMS 5 120 24 R100-W PHF910
Diameter: DC	Ø 12 mm
Cutting speed: Vc	120 m/min
Feed per tooth: fz	0,07 mm/t
Depth of cut: ap	24 mm (2xDC)
Stepover : ae	ae = 1,2 mm (10%)
Time	8 hours and 30 minutes

End mill	HR38TSMS 5 160 32 R100-W PHF910
Diameter: DC	Ø 16 mm
Cutting speed: Vc	150 m/min
Feed per tooth: fz	0,10 mm/t
Depth of cut: ap	32 mm (2xDC)
Stepover : ae	ae = 1,6 mm (10%)
Time	3 hours

HR38TSM

Competitor

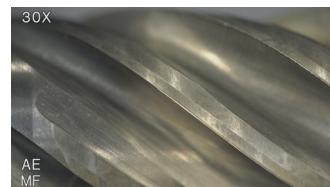
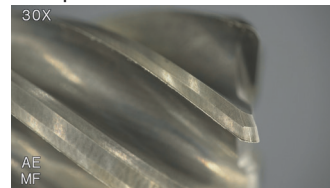
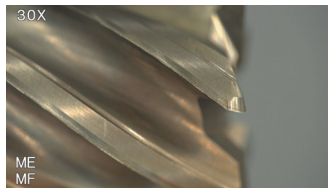

HR38TSM

Competitor

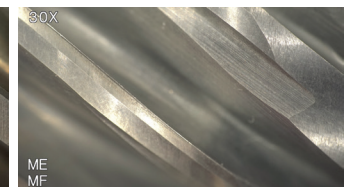
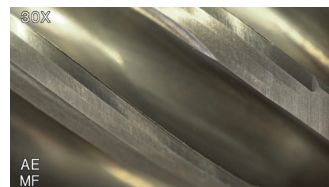
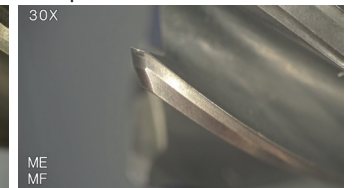
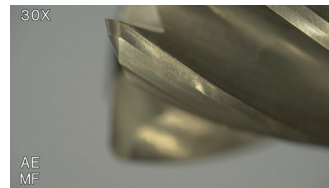

Test 1: Tool wear after 8 hours and 30 minutes of machining

Test 2: Tool wear after 3 hours of machining

DYN-INTEG

HR38TSM

Trochoidal milling for stainless steels and super alloys



Check the QrCode to our website for more information



HEADQUARTERS

PALBIT. S.A.

T (+351) 234 540 300 | F (+351) 234 540 301

palbit@palbit.pt | www.palbit.pt

Branch office

PALBIT México, S de RL de CV

T (+52) 5555 454 543 | F (+52) 5552 509 190

info@palbit.com.mx | www.palbit.pt/mx

Branch office

PALBIT Brasil

T (+55) 011 25 343 648

palbit@palbit.com.br | www.palbit.pt/br