



D - GROOVING & PARTING OFF

D - 730 | Inserts overview

D - 732 | GROOVING PLUS

D - 732 | Inserts code key

D - 733 | GP Inserts

D - 736 | Blades & Toolholders code key

D - 742 | GROOVING & PARTING OFF



GROOVING & PARTING OFF

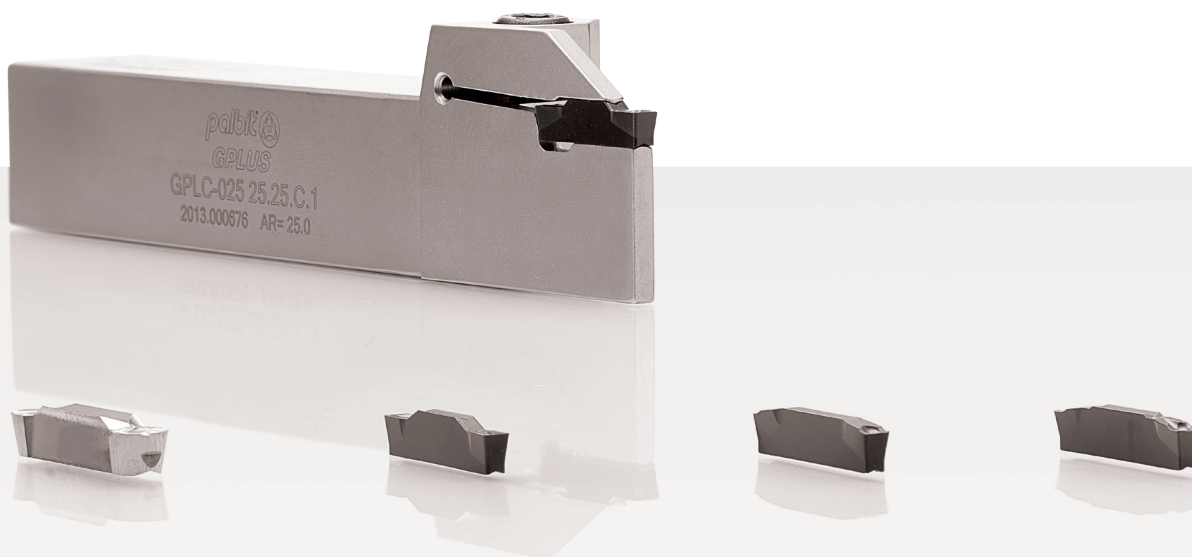

D - 742 | Inserts code key & Overview

D - 743 | Inserts

D - 747 | Blades code key

D - 751 | Trigon Inserts

D - 754 | Trigon Toolholders

D - 758 | SAL (Swiss Automatic Lathes)

D - 760 | Inserts & toolholders code key

D - 762 | Toolholders

D - 763 | Inserts

D - 766 | Technical data

D - 768 | LIGHT GROOVING











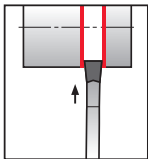
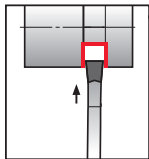
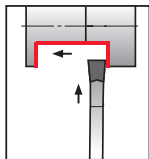
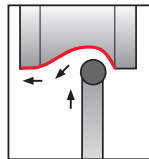
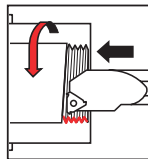

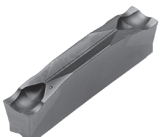



D - 772 | FORMING GROOVING

D - 776 | SPARE PARTS

D - 777 | TECHNICAL DATA











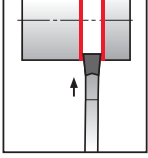
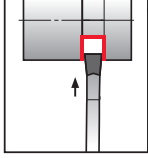
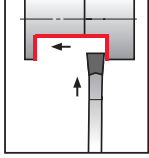
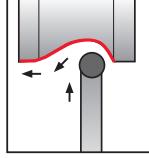
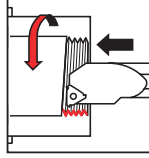



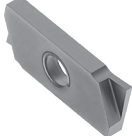

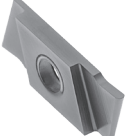

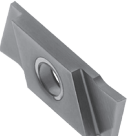
GENERAL INSERTS OVERVIEW

D
 GROOVING & PARTING OFF
 Grooving Plus
 Grooving & Parting Off
 SAL - Swiss Automatic Lathes
 Light Grooving
 Forming Grooving
 Technical Data

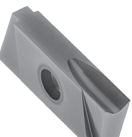
Operation Insert Type + Chipbreaker		Parting Off	General Grooving	Turning	Profiling	Threading
						
	GP...-N01-MC GP...-R01-MC GP...-L01-MC					
	GP...-N02-MC GP...-R02-MC GP...-L02-MC					
	GP...-N02-MG					
	GP...-N02-MM					
	GP...-N02-MP					
	GP...-N02-NP					
	GCMX...					
	SANCAR...					

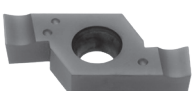
 First choice | Primeira opção | Primera opción

 Alternative | Alternativa

Insert Type + Chipbreaker		Operation		Parting Off	General Grooving	Turning	Profiling	Threading
								
	TRIGON							
	SAL GS							
	SAL GR							
	SAL P							
	SAL PT							
	SAL TP							
	LG							
	FG							

 First choice | Primeira opção | Primera opción

 Alternative | Alternativa

GP INSERTS CODE KEY

Chave de codificação para pastilhas GP | Llave de codificación para plaquitas GP

For R or L Insert type

GP	0300	B	020	-	050	R	02	-	MC
1	2	3	4		5	6	7		8

For N Insert type

GP	0300	B	020	-	N	02	-	MC
1	2	3	4		6	7		8

1 - Product Line

GP - Grooving Plus

2 - Cutting Width

0200 - 2,00mm | 0300 - 3,00mm | 0400 - 4,00mm | 0500 - 5,00mm | 0600 - 6,00mm

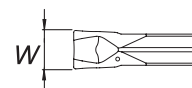

3 - Seat Size

A - GP0200 | B - GP0300 | C - GP0400 | D - GP0500 | E - GP0600

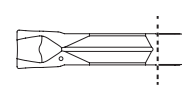

4 - Cutting Radius

020 - 0,20mm | 025 - 0,25mm | 040 - 0,40mm | 600 - 6,00mm

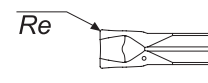

5 - Relief Angle

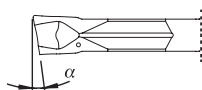

6 - Insert Type

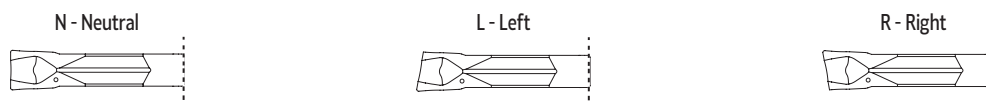

7 - N° of Cutting Edges



8 - Chipbreaker

MC - Medium Cut Off | MG - Medium Grooving | MM - Medium Multi Function | MP - Medium Profiling | NP - Non-Ferrous Profiling

GP...01-MC | Medium Cut Off

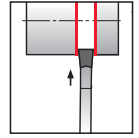
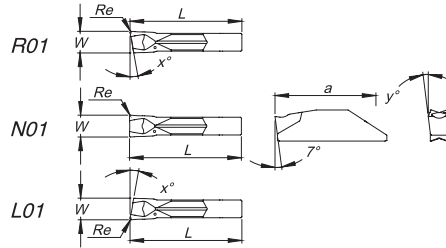

(1) Geometry code	(2) Grade code	P				M			K			S		Dimensions (mm)							Cutting Conditions														
		CVD		PVD		CVD		PVD	CVD			PVD		W	Re	L	x°	a ¹	y°	Seat ² Size	fn (mm/r)	Min	Max												
		N2	U6	G4	P4	U6	G4	P4	L6	N2	U6	G4	P4																						
		PH5135	PHS135	PH7920	PHP930	PHS135	PH7920	PHP930	PH5320	PH5135	PHS135	PH7920	PHP930																						
1130422	GP0200A020-N01-MC	⊕	⊗	⊕	⊗	⊗	⊕	⊗	⊗	⊕	⊗	⊕	⊗	2,0	0,2	20,2	-	-	6,0	A	0,06	0,05	0,10												
1130423	GP0300B020-N01-MC	⊕	⊗	⊕	⊗	⊗	⊕	⊗	⊗	⊕	⊗	⊕	⊗	3,0	0,2	20,1	-	-	8,0	B	0,08	0,05	0,15												
1130424	GP0400C020-N01-MC	⊕	⊗	⊕	⊗	⊗	⊕	⊗	⊗	⊕	⊗	⊕	⊗	4,0	0,2	20,5	-	-	7,0	C	0,13	0,05	0,25												
1130425	GP0200A020-050R01-MC	⊕	⊗	⊕	⊗	⊗	⊕	⊗	⊗	⊕	⊗	⊕	⊗	2,0	0,2	20,2	5,0	-	6,0	A	0,05	0,04	0,08												
1130426	GP0300B020-050R01-MC	⊕	⊗	⊕	⊗	⊗	⊕	⊗	⊗	⊕	⊗	⊕	⊗	3,0	0,2	20,1	5,0	-	8,0	B	0,07	0,04	0,12												
1130427	GP0400C020-050R01-MC	⊕	⊗	⊕	⊗	⊗	⊕	⊗	⊗	⊕	⊗	⊕	⊗	4,0	0,2	20,5	5,0	-	7,0	C	0,10	0,04	0,20												
1130428	GP0200A020-050L01-MC	⊕	⊗	⊕	⊗	⊗	⊕	⊗	⊗	⊕	⊗	⊕	⊗	2,0	0,2	20,2	5,0	-	6,0	A	0,05	0,04	0,08												
1130429	GP0300B020-050L01-MC	⊕	⊗	⊕	⊗	⊗	⊕	⊗	⊗	⊕	⊗	⊕	⊗	3,0	0,2	20,1	5,0	-	8,0	B	0,07	0,04	0,12												
1130430	GP0400C020-050L01-MC	⊕	⊗	⊕	⊗	⊗	⊕	⊗	⊗	⊕	⊗	⊕	⊗	4,0	0,2	20,5	5,0	-	7,0	C	0,10	0,04	0,20												

⊗ First choice | Primeira opção | 1ª opción ⊕ Stock item | Produto de stock | Itens de stock ○ Available under request | Disponível sobre consulta / Disponible bajo consulta

⊕ Stock available until sold out | Stock disponível até acabar o stock | Stock disponible hasta acabar el stock

Insert order code = (1) Geometry Code + (2) Grade Code

1 - When using inserts with 1 Cutting edge, the "a" measure is given by the Toolholder | 2 - Correspond to a Specific Holder

GP...02-MC | Medium Cut Off

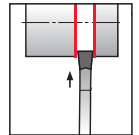
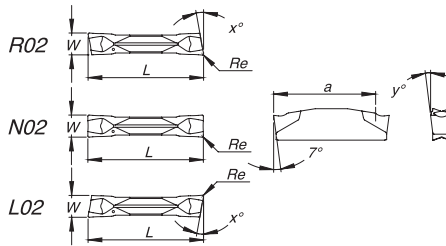

(1) Geometry code	(2) Grade code	P				M			K			S		Dimensions (mm)							Cutting Conditions													
		CVD		PVD		CVD		PVD	CVD			PVD		W	Re	L	x°	a	y°	Seat ² Size	fn (mm/r)	Min	Max											
		N2	U6	G4	P4	U6	G4	P4	L6	N2	U6	G4	P4																					
		PH5135	PHS135	PH7920	PHP930	PHS135	PH7920	PHP930	PH5320	PH5135	PHS135	PH7920	PHP930																					
1130383	GP0200A020-N02-MC	⊕	⊗	⊕	⊗	⊗	⊕	⊗	⊗	⊕	⊗	⊕	⊗	2,0	0,2	20,5	-	18,5	6,0	A	0,06	0,05	0,10											
1130384	GP0300B020-N02-MC	⊕	⊗	⊕	⊗	⊗	⊕	⊗	⊗	⊕	⊗	⊕	⊗	3,0	0,2	20,4	-	18,5	8,0	B	0,08	0,05	0,15											
1130397	GP0400C020-N02-MC	⊕	⊗	⊕	⊗	⊗	⊕	⊗	⊗	⊕	⊗	⊕	⊗	4,0	0,2	21,0	-	18,5	7,0	C	0,13	0,05	0,25											
1130416	GP0200A020-050R02-MC	⊕	⊗	⊕	⊗	⊗	⊕	⊗	⊗	⊕	⊗	⊕	⊗	2,0	0,2	20,5	5,0	18,5	6,0	A	0,05	0,04	0,08											
1130417	GP0300B020-050R02-MC	⊕	⊗	⊕	⊗	⊗	⊕	⊗	⊗	⊕	⊗	⊕	⊗	3,0	0,2	20,4	5,0	18,5	8,0	B	0,07	0,04	0,12											
1130418	GP0400C020-050R02-MC	⊕	⊗	⊕	⊗	⊗	⊕	⊗	⊗	⊕	⊗	⊕	⊗	4,0	0,2	21,0	5,0	18,5	7,0	C	0,10	0,04	0,20											
1130419	GP0200A020-050L02-MC	⊕	⊗	⊕	⊗	⊗	⊕	⊗	⊗	⊕	⊗	⊕	⊗	2,0	0,2	20,5	5,0	18,5	6,0	A	0,05	0,04	0,08											
1130420	GP0300B020-050L02-MC	⊕	⊗	⊕	⊗	⊗	⊕	⊗	⊗	⊕	⊗	⊕	⊗	3,0	0,2	20,4	5,0	18,5	8,0	B	0,07	0,04	0,12											
1130421	GP0400C020-050L02-MC	⊕	⊗	⊕	⊗	⊗	⊕	⊗	⊗	⊕	⊗	⊕	⊗	4,0	0,2	21,0	5,0	18,5	7,0	C	0,10	0,04	0,20											

⊗ First choice | Primeira opção | 1ª opción ⊕ Stock item | Produto de stock | Itens de stock ○ Available under request | Disponível sobre consulta / Disponible bajo consulta

Insert order code = (1) Geometry Code + (2) Grade Code

⊕ Stock available until sold out | Stock disponível até acabar o stock | Stock disponible hasta acabar el stock

2 - Correspond to a Specific Holder

GP...02-MG | Medium Grooving

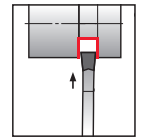
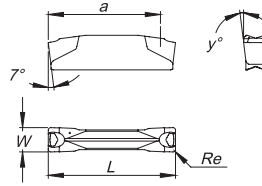

(1) Geometry code	(2) Grade code	P				M			K		S		Dimensions (mm)						Cutting Conditions			
		CVD		PVD		CVD		PVD	CVD		PVD		W	Re	L	x°	a	y°	Seat ² Size	fn (mm/r)	Min	Max
		L8	U6	G4	T1	U6	G4	T1	L6	U6	G4	T1										
1130398	GP0300B020-N02-MG	⊗	⊗	⊗	⊗	⊗	⊗	⊗	⊗	⊗	⊗	⊗	3,0	0,2	21,0	-	18,5	6,5	B	0,06	0,05	0,10
1130399	GP0400C040-N02-MG	⊗	⊗	⊗	⊗	⊗	⊗	⊗	⊗	⊗	⊗	⊗	4,0	0,4	21,0	-	18,5	6,5	C	0,08	0,05	0,15
1130400	GP0500D040-N02-MG	⊗	⊗	⊗	⊗	⊗	⊗	⊗	⊗	⊗	⊗	⊗	5,0	0,4	21,0	-	18,5	6,0	D	0,13	0,05	0,25

⊗ First choice | Primeira opção | 1ª opción
 ⊗ Stock item | Produto de stock | Itens de stock
 ○ Available under request | Disponível sobre consulta
 ○ Available under request | Disponível sobre consulta
 ⊗ Stock available until sold out | Stock disponível até acabar o stock | Stock disponible hasta acabar el stock
 Insert order code = (1) Geometry Code + (2) Grade Code

2 - Correspond to a Specific Holder

GP...02-MM | Medium Multi Function

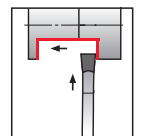
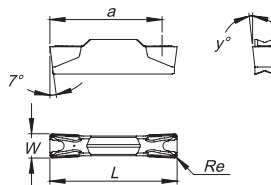

(1) Geometry code	(2) Grade code	P				M				K			S			Dimensions (mm)						Cutting Conditions				
		CVD		PVD		CVD		PVD		CVD		UNC	PVD		W	Re	L	a ¹	y°	Seat ² Size	Ap (mm)	Min	Max	fn (mm/r)	Min	Max
		U6	G4	T1	P4	U6	G4	T1	P4	L6	U6	25	G4	T1												
1130401	GP0300B040-N02-MM	⊗	⊗	⊗	⊗	⊗	⊗	⊗	⊗	⊗	⊗	⊗	⊗	⊗	3,0	0,4	21,0	18,5	6,0	B	0,8	0,4	1,5	0,09	0,05	0,12
1130402	GP0400C040-N02-MM	⊗	⊗	⊗	⊗	⊗	⊗	⊗	⊗	⊗	⊗	⊗	⊗	4,0	0,4	21,0	18,5	6,0	C	1,1	0,6	2,0	0,12	0,07	0,15	
1130403	GP0500D040-N02-MM	⊗	⊗	⊗	⊗	⊗	⊗	⊗	⊗	⊗	⊗	⊗	⊗	5,0	0,4	21,0	18,5	5,5	D	1,5	0,8	2,5	0,14	0,10	0,18	

⊗ First choice | Primeira opção | 1ª opción
 ⊗ Stock item | Produto de stock | Itens de stock
 ○ Available under request | Disponível sobre consulta
 ○ Available under request | Disponível sobre consulta
 ⊗ Stock available until sold out | Stock disponível até acabar o stock | Stock disponible hasta acabar el stock
 Insert order code = (1) Geometry Code + (2) Grade Code

1 - When using inserts with 1 Cutting edge, the "a" measure is given by the Toolholder | 2 - Correspond to a Specific Holder

GP...02-MP | Medium Profiling

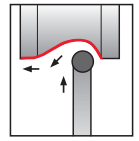
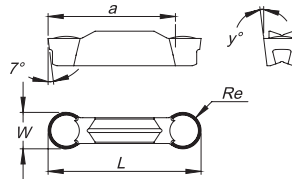

(1) Geometry code	(2) Grade code	P		M		K	S		Dimensions (mm)					Cutting Conditions						
		PVD		PVD		CVD	PVD													
		G4	T1	G4	T1	L6	G4	T1	W	Re	L	a	y°	Seat ² Size	Ap (mm)	Min	Max	fn (mm/r)	Min	Max
1130607	GP0300B150-N02-MP	⊗	⊗	⊗	⊗	⊗	⊗	⊗	3,0	1,5	21,1	18,5	7,0	B	0,7	0,04	1,1	0,09	0,04	0,12
1130404	GP0600E300-N02-MP	⊗	⊗	⊗	⊗	⊗	⊗	⊗	6,0	3,0	25,2	21,0	7,0	E	1,50	0,04	2,20	0,18	0,15	0,22

⊗ First choice | Primeira opção | 1ª opción ⊗ Stock item | Produto de stock | Itens de stock ○ Available under request | Disponível sobre consulta / Disponible bajo consulta Insert order code = (1) Geometry Code + (2) Grade Code

⊗ Stock available until sold out | Stock disponível até acabar o stock | Stock disponible hasta acabar el stock

2 - Correspond to a Specific Holder

GP...02-NP | Non-Ferrous Profiling

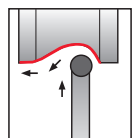
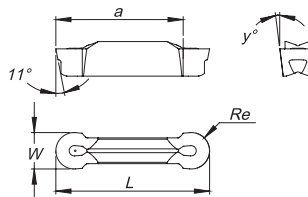

(1) Geometry code	(2) Grade code	N		Dimensions (mm)							Cutting Conditions				
		UNC	10												
		PH0910	W	Re	L	x°	a	y°	Seat ² Size	Ap (mm)	Min	Max	fn (mm/r)	Min	Max
1130405	GP0600E300-N02-NP	⊗	6,0	3,0	25,4	-	18,5	7,0	E	1,30	0,50	2,50	0,20	0,15	0,25

⊗ First choice | Primeira opção | 1ª opción ⊗ Stock item | Produto de stock | Itens de stock ○ Available under request | Disponível sobre consulta / Disponible bajo consulta Insert order code = (1) Geometry Code + (2) Grade Code

⊗ Stock available until sold out | Stock disponível até acabar o stock | Stock disponible hasta acabar el stock

2 - Correspond to a Specific Holder

BLADES & TOOLHOLDERS CODE KEY

Chave de codificação para lâminas | Llave de codificación de lamas

For Blades

GP	N	C	-	080	25	.A	.0
1	2	3		5	6	7	8

For Toolholders

GP	R	C	-	100	010	25.25	.A	.1
1	2	3		4	5	6	7	8

1 - Product Line

GP - Grooving Plus

2 - Work Side

R - Right



N - Neutral



L - Left



3 - Tool Type

C - Frontal

4 - Total toolholder length

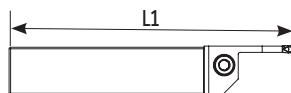

5 - Maximum Depth of Cut

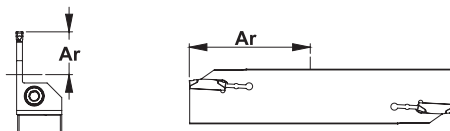

6 - Shaft | Cutting Unit Dimension

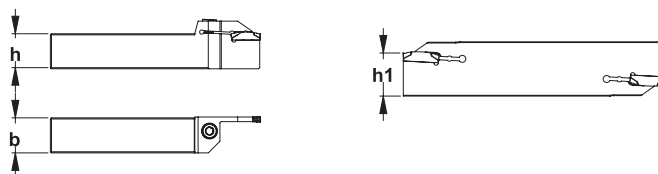

7 - Seat Size

A - 1,60mm | B - 2,30mm | C - 3,30mm | D - 4,30mm | E - 4,00mm | F - 6,60mm

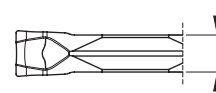

8 - Clamping System

0 - Spring

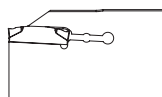

1 - Screw

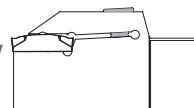

GPNC

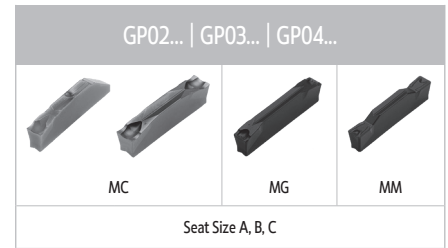

Order code Código	Reference Referência Referencia	Dimensions Dimensões Dimensiones (mm)							Insert	Toolholder		Wrench	Stock
		ar	L1	h	h1	b	W	Seat Size		CPTS	DPTS		
213010000	GPNC-020 25.A.0	20	150	32	25,0	1,5	2	A	GP02...	CPTS 32...	DPTS 32...	LE25-30	☉
213009900	GPNC-055 25.B.0	55	150	32	25,0	2,3	3	B	GP03...	CPTS 32...	DPTS 32...	LE25-30	☉
213009700	GPNC-055 25.C.0	55	150	32	25,0	2,3	4	C	GP04...	CPTS 32...	DPTS 32...	LE25-30	☉

☉ Stock item | Produto de stock | Itens de stock ○ Available under request | Disponível sobre consulta | Disponible bajo consulta

Note: For inserts with 2 cutting edges, the ar is defined by the insert

CPTS

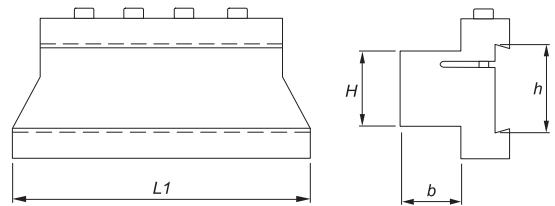

Order code Código	Reference Referência Referencia	Dimensions Dimensões Dimensiones (mm)				Kg	Screw	Wrench	Stock
		h	L1	H	b				
290006200	CPTS 3220	32	100	20	20	0,700	D0603600	SS50	☉
290005000	CPTS 3225	32	110	25	25	0,950	D0603600	SS50	☉
290006300	CPTS 3232	32	120	32	32	1,400	D0603600	SS50	☉

☉ Stock item | Produto de stock | Itens de stock ○ Available under request | Disponível sobre consulta | Disponible bajo consulta

DPTS

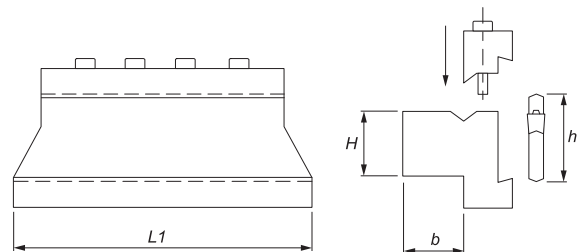
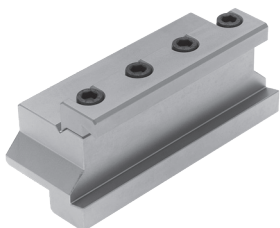

Order code Código	Reference Referência Referencia	Dimensions Dimensões Dimensiones (mm)				Kg	Screw	Wrench	Stock
		h	L1	H	b				
290073600	DPTS 3220	32	100	20	20	0,750	D0603600	SS50	☉
290073700	DPTS 3225	32	110	25	25	1,00	D0603600	SS50	☉
290073800	DPTS 3232	32	120	32	32	1,450	D0603600	SS50	☉

☉ Stock item | Produto de stock | Itens de stock ○ Available under request | Disponível sobre consulta | Disponible bajo consulta

GPLC

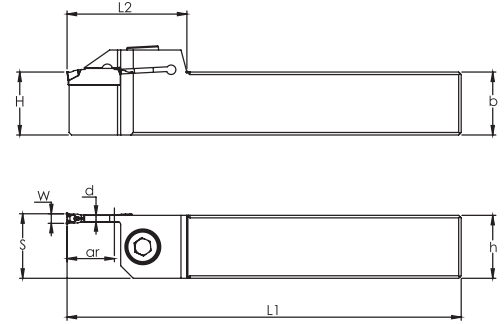
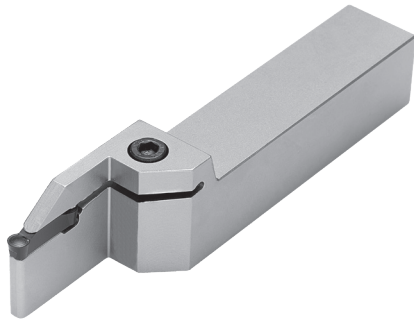

Order code Código	Reference Referência Referencia	Dimensions Dimensões Dimensiones (mm)								Seat Size	Insert	Screw	Wrench	Nm	Stock
		ar	L1	h	b	H	L2	S	W						
183020800	GPLC-100 010 16.16.A.1	10	100	16	16	16	30	16,25	2	A	GP02...	D0602200	SS50	2,0	○
183020900	GPLC-100 015 16.16.A.1	15	100	16	16	16	38	16,25	2		GP02...	D0602200	SS50	2,0	⊗
183021000	GPLC-125 010 20.20.A.1	10	125	20	20	20	32	20,25	2		GP02...	D0602600	SS50	2,0	○
183021100	GPLC-125 015 20.20.A.1	15	125	20	20	20	38	20,25	2		GP02...	D0602600	SS50	2,0	⊗
183021200	GPLC-150 010 25.25.A.1	10	150	25	25	25	34	25,25	2		GP02...	D0603100	SS50	2,0	⊗
183021300	GPLC-150 020 25.25.A.1	20	150	25	25	25	42	25,25	2		GP02...	D0603100	SS50	2,0	⊗
183021400	GPLC-100 010 16.16.B.1	10	100	16	16	16	30	16,5	3	B	GP03...	D0602200	SS50	2,0	○
183021500	GPLC-100 015 16.16.B.1	15	100	16	16	16	38	16,5	3		GP03...	D0602200	SS50	2,0	⊗
183021600	GPLC-125 010 20.20.B.1	10	125	20	20	20	32	20,5	3		GP03...	D0602600	SS50	2,0	○
183021700	GPLC-125 015 20.20.B.1	15	125	20	20	20	38	20,5	3		GP03...	D0602600	SS50	2,0	⊗
183021800	GPLC-150 010 25.25.B.1	10	150	25	25	25	34	25,5	3		GP03...	D0603100	SS50	2,0	⊗
183021900	GPLC-150 020 25.25.B.1	20	150	25	25	25	42	25,5	3		GP03...	D0603100	SS50	2,0	⊗
183022000	GPLC-125 013 20.20.C.1	13	125	20	20	20	32	20,5	4	C	GP04...	D0602600	SS50	3,0	○
183022100	GPLC-125 019 20.20.C.1	19	125	20	20	20	38	20,5	4		GP04...	D0602600	SS50	3,0	⊗
183022200	GPLC-150 013 25.25.C.1	13	150	25	25	25	34	25,5	4		GP04...	D0603100	SS50	3,0	⊗
183022300	GPLC-150 023 25.25.C.1	23	150	25	25	25	42	25,5	4		GP04...	D0603100	SS50	3,0	⊗
183022400	GPLC-125 013 20.20.D.1	13	125	20	20	20	32	20,5	5	D	GP05...	D0602600	SS50	3,0	○
183022500	GPLC-125 019 20.20.D.1	19	125	20	20	20	38	20,5	5		GP05...	D0602600	SS50	3,0	⊗
183022600	GPLC-150 013 25.25.D.1	13	150	25	25	25	34	25,5	5		GP05...	D0603100	SS50	3,0	⊗
183022700	GPLC-150 023 25.25.D.1	23	150	25	25	25	42	25,5	5		GP05...	D0603100	SS50	3,0	⊗
183022800	GPLC-150 015 25.25.E.1	15	150	25	25	25	34	26	6	E	GP06...	D0603100	SS50	4,0	⊗
183022900	GPLC-150 023 25.25.E.1	23	150	25	25	25	42	26	6		GP06...	D0603100	SS50	4,0	⊗

⊗ Stock item | Produto de stock | Itens de stock ○ Available under request | Disponível sobre consulta | Disponible bajo consulta

Note: For inserts with 2 cutting edges, the ar is defined by the insert

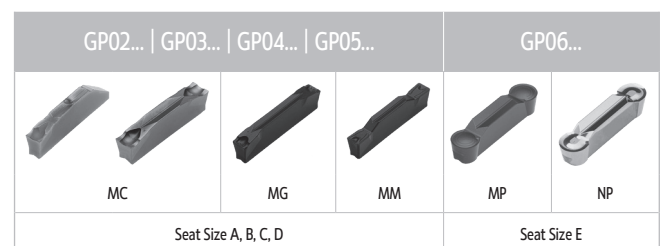

GPRC

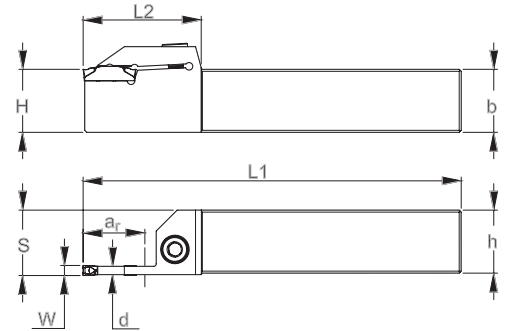
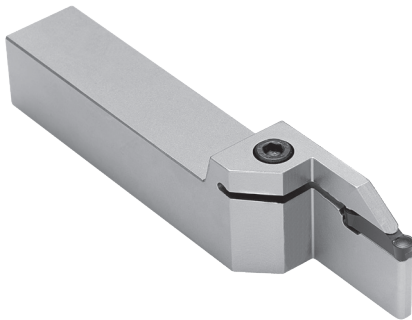

Order code Código	Reference Referência Referencia	Dimensions Dimensões Dimensiones (mm)								Seat Size	Insert	Screw	Wrench	Nm	Stock
		ar	L1	h	b	H	L2	S	W						
183018400	GPRC-100 010 16.16.A.1	10	100	16	16	16	30	16,25	2	A	GP02...	D0602200	SS50	2,0	○
183018500	GPRC-100 015 16.16.A.1	15	100	16	16	16	38	16,25	2		GP02...	D0602200	SS50	2,0	⊗
183018600	GPRC-125 010 20.20.A.1	10	125	20	20	20	32	20,25	2		GP02...	D0602600	SS50	2,0	○
183018700	GPRC-125 015 20.20.A.1	15	125	20	20	20	38	20,25	2		GP02...	D0602600	SS50	2,0	⊗
183018800	GPRC-150 010 25.25.A.1	10	150	25	25	25	34	25,25	2		GP02...	D0603100	SS50	2,0	⊗
183018900	GPRC-150 020 25.25.A.1	20	150	25	25	25	42	25,25	2		GP02...	D0603100	SS50	2,0	⊗
183019000	GPRC-100 010 16.16.B.1	10	100	16	16	16	30	16,5	3	B	GP03...	D0602200	SS50	2,0	○
183019100	GPRC-100 015 16.16.B.1	15	100	16	16	16	38	16,5	3		GP03...	D0602200	SS50	2,0	⊗
183019200	GPRC-125 010 20.20.B.1	10	125	20	20	20	32	20,5	3		GP03...	D0602600	SS50	2,0	○
183019300	GPRC-125 015 20.20.B.1	15	125	20	20	20	38	20,5	3		GP03...	D0602600	SS50	2,0	⊗
183019400	GPRC-150 010 25.25.B.1	10	150	25	25	25	34	25,5	3		GP03...	D0603100	SS50	2,0	⊗
183019500	GPRC-150 020 25.25.B.1	20	150	25	25	25	42	25,5	3		GP03...	D0603100	SS50	2,0	⊗
183018300	GPRC-125 013 20.20.C.1	13	125	20	20	20	32	20,5	4	C	GP04...	D0602600	SS50	3,0	○
183018200	GPRC-125 019 20.20.C.1	19	125	20	20	20	38	20,5	4		GP04...	D0602600	SS50	3,0	⊗
183018100	GPRC-150 013 25.25.C.1	13	150	25	25	25	34	25,5	4		GP04...	D0603100	SS50	3,0	⊗
183018000	GPRC-150 023 25.25.C.1	23	150	25	25	25	42	25,5	4		GP04...	D0603100	SS50	3,0	⊗
183017900	GPRC-125 013 20.20.D.1	13	125	20	20	20	32	20,5	5	D	GP05...	D0602600	SS50	3,0	○
183017800	GPRC-125 019 20.20.D.1	19	125	20	20	20	38	20,5	5		GP05...	D0602600	SS50	3,0	⊗
183017700	GPRC-150 013 25.25.D.1	13	150	25	25	25	34	25,5	5		GP05...	D0603100	SS50	3,0	⊗
183017600	GPRC-150 023 25.25.D.1	23	150	25	25	25	42	25,5	5		GP05...	D0603100	SS50	3,0	⊗
183017500	GPRC-150 015 25.25.E.1	15	150	25	25	25	34	26	6	E	GP06...	D0603100	SS50	4,0	⊗
183020500	GPRC-150 023 25.25.E.1	23	150	25	25	25	42	26	6		GP06...	D0603100	SS50	4,0	⊗

⊗ Stock item | Produto de stock | Itens de stock ○ Available under request | Disponível sobre consulta | Disponible bajo consulta

Note: For inserts with 2 cutting edges, the ar is defined by the insert

GP02... GP03... GP04... GP05...				GP06...	
MC	MG	MM	MP	NP	NP
Seat Size A, B, C, D				Seat Size E	

Feed recommendations and geometry descriptions

Grooving & Parting Off

GP...02-MC

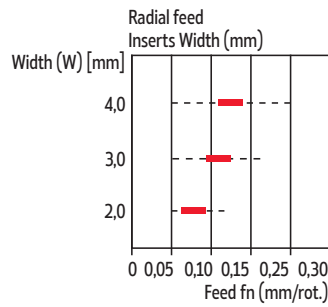
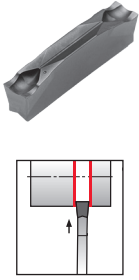

Medium Parting Off

Recommended for parting off, thin walled tubes and small diameter components in all materials.

The positive geometry eliminates the risk of built-up edge.

Low cutting forces resulting in reduced vibration.

GP...02-MG

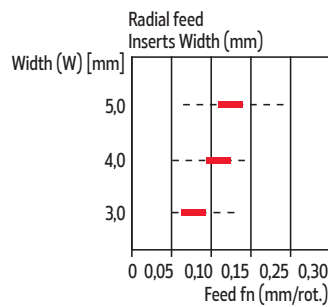
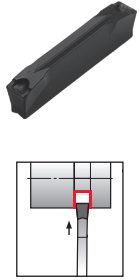

Medium Grooving

Outstanding chip control.

Reduces chip width giving good surfaces.

For all materials.

GP...02-MM

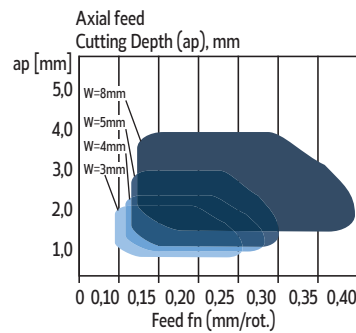
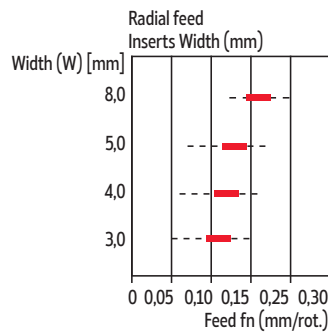
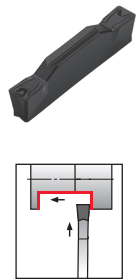

Medium Multi Function (Grooving & Turning)

For grooving and turning in all materials.

Good chip control.

D

GROOVING & PARTING OFF

Grooving Plus

Grooving & Parting Off

SAL - Swiss Automatic Lathes

Light Grooving

Forming Grooving

Technical Data

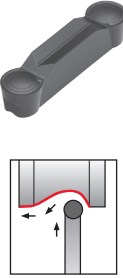
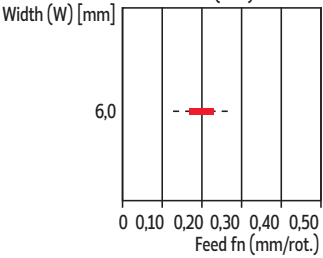
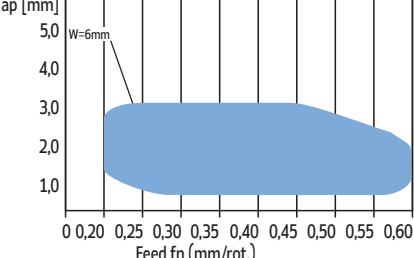
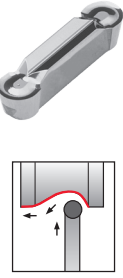
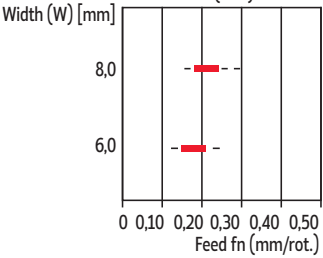
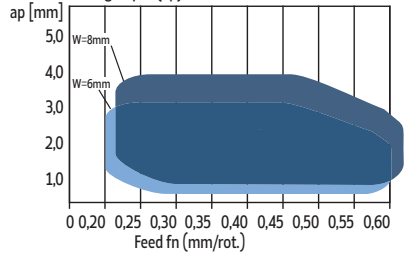
Feed recommendations and geometry descriptions		Grooving & Parting Off	
<p>GP...02-MP</p> 	<p>Radial feed Inserts Width (mm)</p>  <p>Width (W) [mm]</p> <p>6,0</p> <p>0 0,10 0,20 0,30 0,40 0,50</p> <p>Feed fn (mm/rot.)</p>	<p>Axial feed Cutting Depth (ap), mm</p>  <p>ap [mm]</p> <p>W=6mm</p> <p>5,0</p> <p>4,0</p> <p>3,0</p> <p>2,0</p> <p>1,0</p> <p>0 0,20 0,25 0,30 0,35 0,40 0,45 0,50 0,55 0,60</p> <p>Feed fn (mm/rot.)</p>	<p>Medium Profiling</p> <p>For profiling all materials.</p> <p>Outstanding chip control even at low feeds and small depths of cut.</p> <p>Good surface finish.</p>
<p>GP...02-NP</p> 	<p>Radial feed Inserts Width (mm)</p>  <p>Width (W) [mm]</p> <p>8,0</p> <p>6,0</p> <p>0 0,10 0,20 0,30 0,40 0,50</p> <p>Feed fn (mm/rot.)</p>	<p>Axial feed Cutting Depth (ap), mm</p>  <p>ap [mm]</p> <p>W=8mm</p> <p>W=6mm</p> <p>5,0</p> <p>4,0</p> <p>3,0</p> <p>2,0</p> <p>1,0</p> <p>0 0,20 0,25 0,30 0,35 0,40 0,45 0,50 0,55 0,60</p> <p>Feed fn (mm/rot.)</p>	<p>Medium Aluminium profiling</p> <p>First choice for profiling in non-ferrous materials.</p> <p>Good chip flow provides a better surface finishing.</p> <p>Sharp cutting edge.</p>

GCMX & SANCAR INSERTS CODE KEY

Chave de codificação para pastilhas | Llave de codificación para plaquitas

For GCMX Inserts

For SANCAR Inserts

GCMX - **3** **R** **15**

1 **2** **3** **4**

SANCAR - **3** **R** **5**

1 **2** **3** **4**

1 - Product Line



GCMX

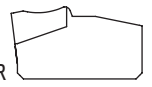

SANCAR

2 - Cutting Width

2mm | 2,4mm | 3mm | 4mm | 4,8mm | 5mm | 6mm

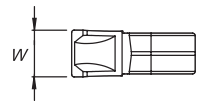

3 - Inserts Type

N - Neutral | R - Right | L - Left

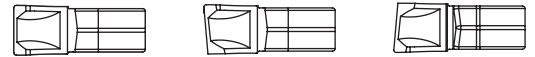

4 - Relief Angle

4 - 4° | 5 - 5° | 8 - 8° | 15 - 15°

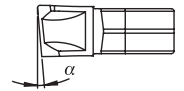

INSERTS OVERVIEW | Visão geral | Visión general

Operation		Parting Off	General Grooving	Turning	Profiling
Insert Type + Chipbreaker		GCMX-...			
		SANCAR-...			

First choice | Primeira opção | Primera opción

Alternative | Alternativa

GCMX-N

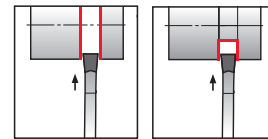
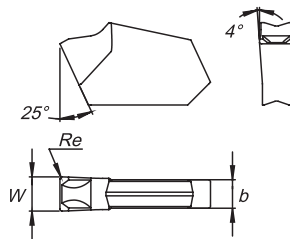
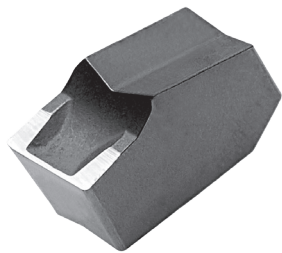

(1) Geometry code	ISO Reference	ANSI Reference	P		M		K		Dimensions (mm)				Cutting Conditions		
			(2) Grade code		CVD-MT	CVD-MT	CVD-MT	L7							N2
			PH5115	PH5135	PH5135	PH5320	PH5135	W	b	Re	α	fn (mm/r)	Min	Max	
1130165	GCMX-2N	GTN-2N	⊗	⊗	⊗	⊗	⊗	⊗	2,2	1,8	0,16	-	0,08	0,05	0,16
1130228	GCMX-2.4N	GTN-2.4N	○	○	○	○	○	○	2,4	2,0	0,16	-	0,10	0,06	0,18
1130169	GCMX-3N	GTN-3N	⊗	⊗	⊗	⊗	⊗	⊗	3,1	2,6	0,20	-	0,15	0,10	0,25
1130174	GCMX-4N	GTN-4N	⊗	⊗	⊗	⊗	⊗	⊗	4,1	3,5	0,25	-	0,18	0,10	0,30
1130229	GCMX-4.8N	GTN-4.8N	○	○	○	○	○	○	4,8	4,2	0,28	-	0,20	0,12	0,35
1130175	GCMX-5N	GTN-5N	⊗	⊗	⊗	⊗	⊗	⊗	5,1	4,5	0,28	-	0,20	0,12	0,35
1130176	GCMX-6N	GTN-6N	⊗	⊗	⊗	⊗	⊗	⊗	6,4	5,5	0,35	-	0,25	0,15	0,40
1130449	GCMX-8N	GTN-8N	○	○	○	○	○	○	8,0	7,1	0,40	-	0,28	0,17	0,45

⊗ First choice | Primeira opção | 1ª opção

⊗ Stock item | Produto de stock | Itens de stock

○ Available under request | Disponível sobre consulta
Disponibile bajo consulta

Insert order code = (1) Geometry Code + (2) Grade Code

INSERTS

GCMX-R

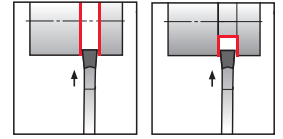
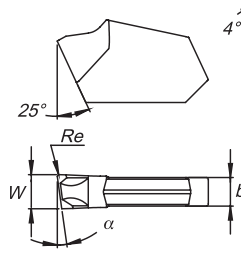

			P		M		K		Dimensions (mm)				Cutting Conditions	
			CVD-MT		CVD-MT		CVD-MT							
			(2) Grade code		L7	N2	N2	L6	N2	W	b	Re	α	fn (mm/r)
(1) Geometry code	ISO Reference	ANSI Reference	PH5115	PH5135	PH5135	PH5320	PH5135							
1130166	GCMX-2R 4	GTN-2R 4	○	○	○	○	○	2,2	1,8	0,16	4	0,07	0,04	0,13
1130167	GCMX-2R 8	GTN-2R 8	○	○	○	○	○	2,2	1,8	0,16	8	0,06	0,04	0,11
1130255	GCMX-2R 15	GTN-2R 15	○	○	○	○	○	2,2	1,8	0,16	15	0,06	0,04	0,09
1130257	GCMX-2.4R 4	GTN-2.4R 4	○	○	○	○	○	2,4	2,0	0,16	4	0,08	0,04	0,14
1130233	GCMX-2.4R 8	GTN-2.4R 8	○	○	○	○	○	2,4	2,0	0,16	8	0,07	0,04	0,12
1130258	GCMX-2.4R 15	GTN-2.4R 15	○	○	○	○	○	2,4	2,0	0,16	15	0,06	0,04	0,10
1130170	GCMX-3R 4	GTN-3R 4	○	○	○	○	○	3,1	2,6	0,20	4	0,08	0,05	0,15
1130171	GCMX-3R 8	GTN-3R 8	○	○	○	○	○	3,1	2,6	0,20	8	0,07	0,05	0,12
1130253	GCMX-3R 15	GTN-3R 15	○	○	○	○	○	3,1	2,6	0,20	15	0,06	0,05	0,10
1130261	GCMX-4R 4	GTN-4R 4	○	○	○	○	○	4,1	3,5	0,25	4	0,12	0,08	0,20
1130222	GCMX-4R 8	GTN-4R 8	○	○	○	○	○	4,1	3,5	0,25	8	0,10	0,08	0,12
1130262	GCMX-4R 15	GTN-4R 15	○	○	○	○	○	4,1	3,5	0,25	15	0,10	0,08	0,12
1130264	GCMX-4.8R 4	GTN-4.8R 4	○	○	○	○	○	4,8	4,2	0,28	4	0,18	0,10	0,25
1130230	GCMX-4.8R 8	GTN-4.8R 8	○	○	○	○	○	4,8	4,2	0,28	8	0,13	0,10	0,18
1130265	GCMX-4.8R 15	GTN-4.8R 15	○	○	○	○	○	4,8	4,2	0,28	15	0,12	0,09	0,15
1130268	GCMX-5R 4	GTN-5R 4	○	○	○	○	○	5,1	4,5	0,28	4	0,18	0,10	0,25
1130224	GCMX-5R 8	GTN-5R 8	○	○	○	○	○	5,1	4,5	0,28	8	0,13	0,10	0,18
1130269	GCMX-5R 15	GTN-5R 15	○	○	○	○	○	5,1	4,5	0,28	15	0,12	0,09	0,15
1130272	GCMX-6R 4	GTN-6R 4	○	○	○	○	○	6,4	5,5	0,35	4	0,20	0,10	0,30
1130227	GCMX-6R 8	GTN-6R 8	○	○	○	○	○	6,4	5,5	0,35	8	0,17	0,12	0,20
1130276	GCMX-6R 15	GTN-6R 15	○	○	○	○	○	6,4	5,5	0,35	15	0,14	0,10	0,18

🟢 First choice | Primeira opção | 1ª opción

🟡 Stock item | Produto de stock | Itens de stock

⊖ Available under request | Disponível sobre consulta
Disponibile bajo consulta

Insert order code = (1) Geometry Code + (2) Grade Code

GCMX=L

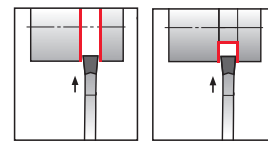
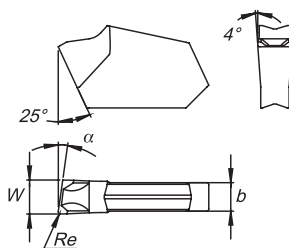

(1) Geometry code	ISO Reference	ANSI Reference	P		M		K		Dimensions (mm)				Cutting Conditions		
			(2) Grade code		CVD-MT	CVD-MT	CVD-MT	L7							N2
			PH5115	PH5135	PH5135	PH5320	PH5135	W	b	Re	α	fn (mm/r)	Min	Max	
1130164	GCMX-2L 4	GTN-2L 4	○	○	○	○	○	○	2,2	1,8	0,16	4	0,07	0,04	0,13
1130220	GCMX-2L 8	GTN-2L 8	○	○	○	○	○	○	2,2	1,8	0,16	8	0,06	0,04	0,11
1130256	GCMX-2L 15	GTN-2L 15	○	○	○	○	○	○	2,2	1,8	0,16	15	0,06	0,04	0,09
1130259	GCMX-2.4L 4	GTN-2.4L 4	○	○	○	○	○	○	2,4	2,0	0,16	4	0,08	0,04	0,14
1130232	GCMX-2.4L 8	GTN-2.4L 8	○	○	○	○	○	○	2,4	2,0	0,16	8	0,07	0,04	0,12
1130260	GCMX-2.4L 15	GTN-2.4L 15	○	○	○	○	○	○	2,4	2,0	0,16	15	0,06	0,04	0,10
1130221	GCMX-3L 4	GTN-3L 4	○	○	○	○	○	○	3,1	2,6	0,20	4	0,08	0,05	0,15
1130168	GCMX-3L 8	GTN-3L 8	○	○	○	○	○	○	3,1	2,6	0,20	8	0,07	0,05	0,12
1130254	GCMX-3L 15	GTN-3L 15	○	○	○	○	○	○	3,1	2,6	0,20	15	0,06	0,05	0,10
1130173	GCMX-4L 4	GTN-4L 4	○	○	○	○	○	○	4,1	3,5	0,25	4	0,12	0,08	0,20
1130223	GCMX-4L 8	GTN-4L 8	○	○	○	○	○	○	4,1	3,5	0,25	8	0,10	0,08	0,12
1130263	GCMX-4L 15	GTN-4L 15	○	○	○	○	○	○	4,1	3,5	0,25	15	0,10	0,08	0,12
1130266	GCMX-4.8L 4	GTN-4.8L 4	○	○	○	○	○	○	4,8	4,2	0,28	4	0,18	0,10	0,25
1130231	GCMX-4.8L 8	GTN-4.8L 8	○	○	○	○	○	○	4,8	4,2	0,28	8	0,13	0,10	0,18
1130267	GCMX-4.8L 15	GTN-4.8L 15	○	○	○	○	○	○	4,8	4,2	0,28	15	0,12	0,09	0,15
1130270	GCMX-5L 4	GTN-5L 4	○	○	○	○	○	○	5,1	4,5	0,28	4	0,18	0,10	0,25
1130225	GCMX-5L 8	GTN-5L 8	○	○	○	○	○	○	5,1	4,5	0,28	8	0,13	0,10	0,18
1130271	GCMX-5L 15	GTN-5L 15	○	○	○	○	○	○	5,1	4,5	0,28	15	0,12	0,09	0,15
1130274	GCMX-6L 4	GTN-6L 4	○	○	○	○	○	○	6,4	5,5	0,35	4	0,20	0,10	0,30
1130226	GCMX-6L 8	GTN-6L 8	○	○	○	○	○	○	6,4	5,5	0,35	8	0,17	0,12	0,20
1130275	GCMX-6L 15	GTN-6L 15	○	○	○	○	○	○	6,4	5,5	0,35	15	0,14	0,10	0,18

🔑 First choice | Primeira opção | 1ª opción

📦 Stock item | Produto de stock | Itens de stock

○ Available under request | Disponível sobre consulta
Disponibile bajo consulta

Insert order code = (1) Geometry Code + (2) Grade Code

SANCAR

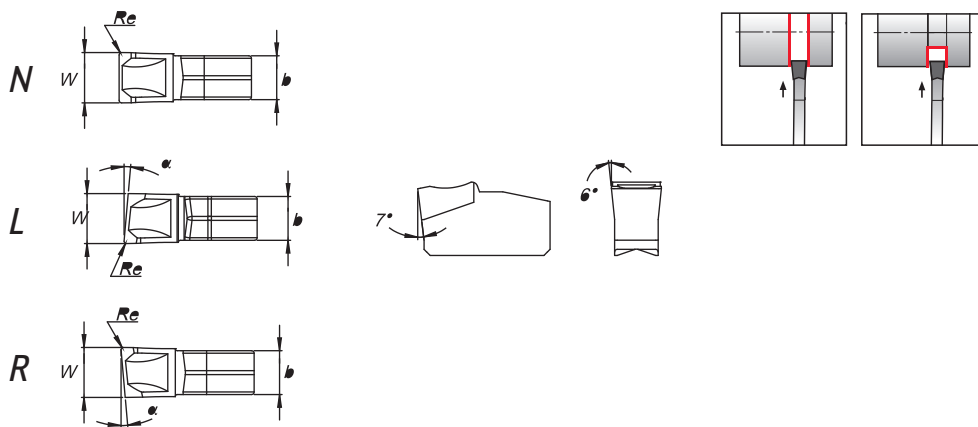

			P		M	K		Dimensions (mm)				Cutting Conditions		
			CVD-MT		CVD-MT	CVD-MT								
	⁽¹⁾ Geometry code	ISO Reference	ANSI Reference	L7	N2	N2	L6	N2	W	b	Re	α	fn (mm/r)	Min
⁽²⁾ Grade code				PH5115	PH5135	PH5135	PH5320	PH5135						
1130186	SANCAR-3N	SANCAR-3N	⊗	⊗	⊗	⊗	⊗	3,0	2,5	0,25	-	0,13	0,05	0,25
1130187	SANCAR-4N	SANCAR-4N	⊗	⊗	⊗	⊗	⊗	4,0	3,3	0,25	-	0,18	0,10	0,30
1130189	SANCAR-5N	SANCAR-5N	⊗	⊗	⊗	⊗	⊗	5,0	4,3	0,25	-	0,22	0,10	0,35
1130185	SANCAR-3L 5	SANCAR-3L 5	○	○	○	○	○	3,0	2,5	0,25	5	0,10	0,05	0,15
1130390	SANCAR-4L 5	SANCAR-4L 5	○	○	○	○	○	4,0	3,3	0,25	5	0,12	0,08	0,20
1130389	SANCAR-5L 5	SANCAL-5L 5	○	○	○	○	○	5,0	4,3	0,25	5	0,15	0,08	0,25
1130288	SANCAR-3R 5	SANCAR-3R 5	○	○	○	○	○	3,0	2,5	0,25	5	0,10	0,05	0,15
1130188	SANCAR-4R 5	SANCAR-4R 5	○	○	○	○	○	4,0	3,3	0,25	5	0,12	0,08	0,20
1130388	SANCAR-5R 5	SANCAR-5R 5	○	○	○	○	○	5,0	4,3	0,25	5	0,15	0,08	0,25

⊗ First choice | Primeira opção | 1ª opción

⊗ Stock item | Produto de stock | Itens de stock

○ Available under request | Disponível sobre consulta
Disponível bajo consulta

Insert order code = (1) Geometry Code + (2) Grade Code



1 - Product Line

BL - Blade

2 - Blade Type

ST - Standard
Blade



S - SANCAR
Blade



3 - Cutting Width

2mm | 3mm | 4mm | 5mm | 6mm



4 - Maximum Depth of Cut

19 - 19mm | 26 - 26mm | 32 - 32mm

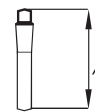

D

GROOVING & PARTING OFF

Grooving Plus

Grooving & Parting Off

SAL - Swiss Automatic Lathes

Light Grooving

Forming Grooving

Technical Data

BLST (GCMX)

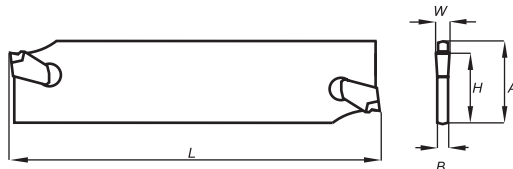

GCMX...



Hand Type
N, R, L

Order code Código	Reference Referência Referencia	Dimensions Dimensões Dimensiones (mm)					Inserts	Toolholder		Wrench	Stock
		A	W	H	B	L		CPTS	DPTS		
183008000	BLST 2-19	19	2	16	1,6	85	GCMX-2...	CPTS 19...	DPTS 19...	LE05	☉
183008100	BLST 2-26	26	2	21,4	1,6	110	GCMX-2...	CPTS 26...	DPTS 26...	LE05	☉
213008200	BLST 3-26	26	3	21,4	2,4	110	GCMX-3...	CPTS 26...	DPTS 26...	LE05	☉
213008300	BLST 4-26	26	4	21,4	3,2	110	GCMX-4...	CPTS 26...	DPTS 26...	LE05	☉
213008400	BLST 5-26	26	5	21,4	4	110	GCMX-5...	CPTS 26...	DPTS 26...	LE05	☉
213008500	BLST 6-26	26	6	21,4	5,2	110	GCMX-6...	CPTS 26...	DPTS 26...	LE05	☉
183008600	BLST 2-32	32	2	25	1,6	150	GCMX-2...	CPTS 32...	DPTS 32...	LE05	☉
213008700	BLST 3-32	32	3	25	2,4	150	GCMX-3...	CPTS 32...	DPTS 32...	LE05	☉
213008800	BLST 4-32	32	4	25	3,2	150	GCMX-4...	CPTS 32...	DPTS 32...	LE05	☉
213008900	BLST 5-32	32	5	25	4	150	GCMX-5...	CPTS 32...	DPTS 32...	LE05	☉
213009000	BLST 6-32	32	6	25	5,2	150	GCMX-6...	CPTS 32...	DPTS 32...	LE05	☉

☉ Stock item | Produto de stock | Itens de stock

○ Available under request | Disponível sobre consulta | Disponible bajo consulta

Note: Check the procedures for inserts extraction on page D-749.

BLS (SANCAR)

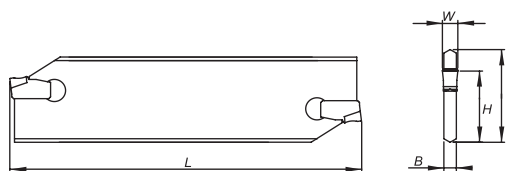

SANCAR...



Hand Type
N, R, L

Order code Código	Reference Referência Referencia	Dimensions Dimensões Dimensiones (mm)					Inserts	Toolholder		Wrench	Stock
		A	W	H	B	L		CPTS	DPTS		
213004600	BLS 3-32	32	3	25	2,4	150	SANCAR 3...	CPTS 32...	DPTS 32...	LE05	☉
213004700	BLS 4-32	32	4	25	3,2	150	SANCAR 4...	CPTS 32...	DPTS 32...	LE05	☉
213005500	BLS 5-32	32	5	25	4	150	SANCAR 5...	CPTS 32...	DPTS 32...	LE05	☉

☉ Stock item | Produto de stock | Itens de stock

○ Available under request | Disponível sobre consulta | Disponible bajo consulta

Note: Check the procedures for inserts extraction on page D-749.

CUTTING PARAMETERS || Parâmetros de corte | Parámetros de corte

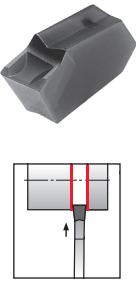
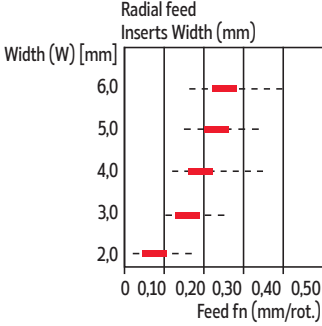
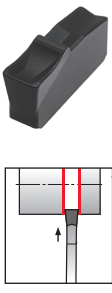
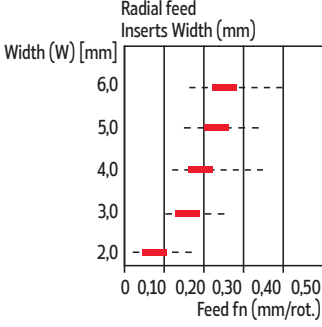
Feed recommendations and geometry descriptions		Grooving & Parting Off
<p>GCMX-...</p> 		<p>Medium Parting Off</p> <p>Most efficient on stainless steel and most types of steel at moderate feed rates. Superior straightness of cut</p>
<p>SANCAR-...</p> 		<p>Medium Parting Off</p> <p>Optimizer to minimize pips and burrs on components. Recommended for steel, stainless steel and cast iron.</p>

— Recommended starting value.
For cutting speed recommendations, see page D-779

PROCEDURES FOR INSERTS EXTRACTION || Procedimentos para remoção de pastilha | Procedimientos para retirar plaquitas

1. Always use the right key to proceed to inserts extraction.
Use sempre a chave adequada para retirar as pastilhas.
Utilice siempre la llave adecuada para retirar la plaquita.
2. Position LE05 key according to **Step 1** and make sure it fits perfectly.
Posicione a chave LE05 de acordo com o **Passo 1** e certifique que está bem encaixada.
Coloque la llave LE05 de acuerdo con el **Paso 1** y asegúrese de que esté correctamente montada.
3. Hold the blade with one hand. With the other hand rotate the LE05 key as illustrated in **Step 2**.
Segure a lâmina com uma mão. Com a outra rode a chave LE05 como ilustrado no **Passo 2**.
Sostenga la lama con una mano. Con la otra gire la llave LE05 como se ilustra en **Paso 2**.
4. Always replace damaged inserts with new ones.
Substitua sempre as pastilhas danificadas por pastilhas novas.
Siempre reemplace las plaquitas dañadas por plaquitas nuevas.

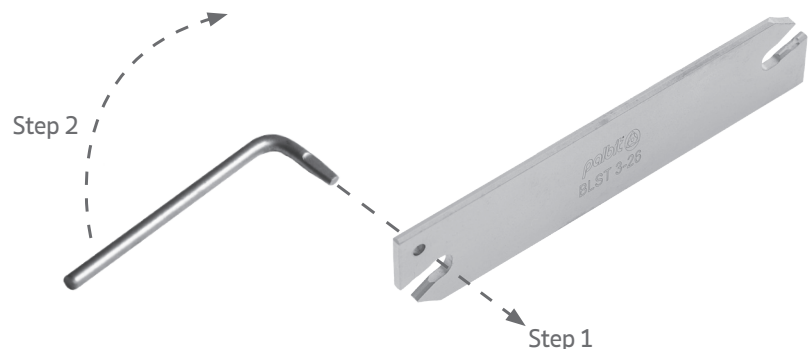

CPTS

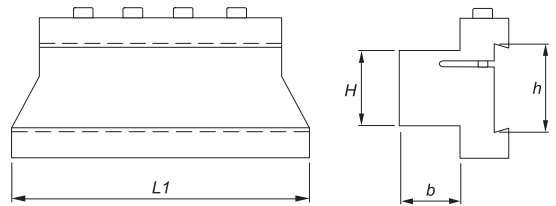

Order code Código	Reference Referência Referencia	Dimensions Dimensões Dimensiones (mm)				Kg	Screw	Wrench	Stock
		h	L1	H	b				
290009300	CPTS 1916	19	76	16	16	0,300	D0503000	SS40	☉
290008200	CPTS 2616	26	76	16	16	0,450	D0603600	SS50	☉
290006000	CPTS 2620	26	87	20	20	0,500	D0603600	SS50	☉
290006100	CPTS 2625	26	87	25	25	0,650	D0603600	SS50	☉
290006200	CPTS 3220	32	100	20	20	0,700	D0603600	SS50	☉
290005000	CPTS 3225	32	110	25	25	0,950	D0603600	SS50	☉
290006300	CPTS 3232	32	120	32	32	1,400	D0603600	SS50	☉

☉ Stock item | Produto de stock | Itens de stock

○ Available under request | Disponível sobre consulta | Disponible bajo consulta

DPTS

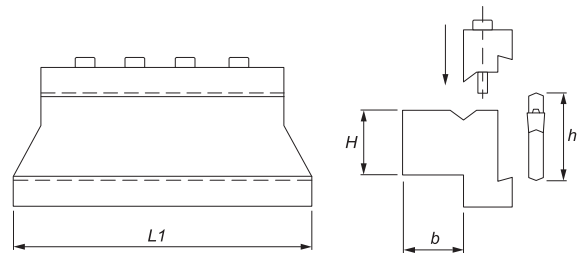

Order code Código	Reference Referência Referencia	Dimensions Dimensões Dimensiones (mm)				Kg	Screw	Wrench	Stock
		h	L1	H	b				
290045400	DPTS 1916	19	76	16	16	0,250	D0503000	SS40	☉
290045500	DPTS 2620	26	87	20	20	0,550	D0603600	SS50	☉
290046600	DPTS 2625	26	87	25	25	0,700	D0603600	SS50	☉
290073600	DPTS 3220	32	100	20	20	0,750	D0603600	SS50	☉
290073700	DPTS 3225	32	110	25	25	1,00	D0603600	SS50	☉
290073800	DPTS 3232	32	120	32	32	1,450	D0603600	SS50	☉

☉ Stock item | Produto de stock | Itens de stock

○ Available under request | Disponível sobre consulta | Disponible bajo consulta

TRIGON INSERTS CODE KEY

Chave de codificação para pastilhas | Llave de codificación para plaquitas

For Trigon 60° Inserts



1 - Inscribed Circle

16 - 9,525mm



2 - Insert Type

ER - External Right | IR - Internal Right

3 - Cutting Edge Type

W - Rectangular



R - Rounded

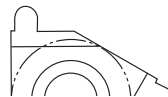

4 - Cutting Edge Length

0,50 - 0,5mm | 2,25 - 2,25mm

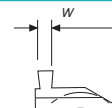

D

GROOVING & PARTING OFF

Grooving Plus

Grooving & Parting Off

SAL - Swiss Automatic Lathes

Light Grooving

Forming Grooving

Technical Data

TRIGON INSERTS

FLAT GROOVING

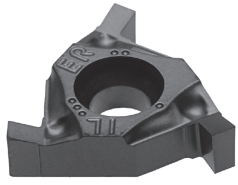

External

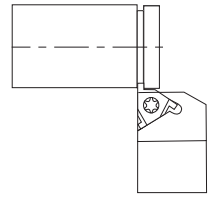
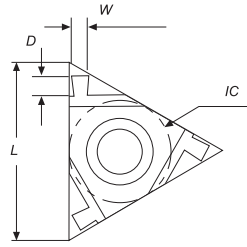

Inserts ER = IL

Order code Código	Reference Referência Referencia	Anvil	Dimensions Dimensões Dimensiones (mm)				Stock - Grade Code (2)	
			IC	L	W	D	(68) PH6920	(D0) PH8920
1883721	11 ER W 0.50	-	6,35	11,00	0,50	1,40	○	○
1883722	11 ER W 0.60	-	6,35	11,00	0,60	1,40	○	○
1883723	11 ER W 0.70	-	6,35	11,00	0,70	1,40	○	○
1883724	11 ER W 0.80	-	6,35	11,00	0,80	1,40	○	○
1883725	11 ER W 1.00	-	6,35	11,00	1,00	1,30	○	○
1883726	16 ER W 0.50	EA 16	9,525	16,00	0,50	1,40	○	○
1881125	16 ER W 1.00	EA 16	9,525	16,00	1,00	1,40	⊗	○
1883707	16 ER W 1.20	EA 16	9,525	16,00	1,20	1,60	⊗	○
1883720	16 ER W 1.40	EA 16	9,525	16,00	1,40	1,80	⊗	○
1881129	16 ER W 1.70	EA 16	9,525	16,00	1,70	2,00	⊗	⊗
1883711	16 ER W 1.95	EA 16	9,525	16,00	1,95	2,00	⊗	⊗
1883714	16 ER W 2.25	EA 16	9,525	16,00	2,25	2,25	⊗	⊗

⊗ Stock item | Produto de stock | Itens de stock

○ Available under request | Disponível sobre consulta
Disponível bajo consulta

Insert order code = (1) Geometry Code + (2) Grade Code

Note: Select the toolholder "SXAN"

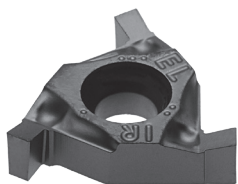

Internal

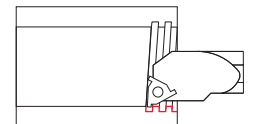
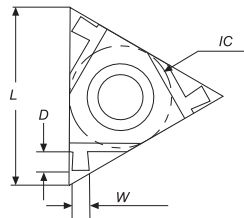

Inserts IR = EL

Order code Código	Reference Referência Referencia	Anvil	Dimensions Dimensões Dimensiones (mm)				Stock - Grade Code (2)	
			IC	L	W	D	(68) PH6920	(D0) PH8920
1881142	11 IR W 0.50	-	6,35	11,00	0,50	1,40	⊗	○
1883727	11 IR W 0.60	-	6,35	11,00	0,60	1,40	○	○
1883728	11 IR W 0.70	-	6,35	11,00	0,70	1,40	○	○
1883729	11 IR W 0.80	-	6,35	11,00	0,80	1,40	○	○
1881144	11 IR W 1.00	-	6,35	11,00	1,00	1,30	⊗	○
1883730	16 IR W 0.50	EA 16	9,525	16,00	0,50	1,40	○	○
1881134	16 IR W 1.00	EA 16	9,525	16,00	1,00	1,40	⊗	○
1883731	16 IR W 1.20	EA 16	9,525	16,00	1,20	1,60	⊗	○
1883712	16 IR W 1.40	EA 16	9,525	16,00	1,40	1,80	⊗	○
1881138	16 IR W 1.70	EA 16	9,525	16,00	1,70	2,00	⊗	○
1883710	16 IR W 1.95	EA 16	9,525	16,00	1,95	2,00	⊗	○
1883713	16 IR W 2.25	EA 16	9,525	16,00	2,25	2,25	⊗	○

⊗ Stock item | Produto de stock | Itens de stock

○ Available under request | Disponível sobre consulta
Disponível bajo consulta

Insert order code = (1) Geometry Code + (2) Grade Code

Note: Select the toolholder "SXFN"

FULL RADIUS GROOVING

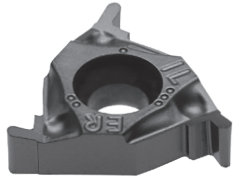

External

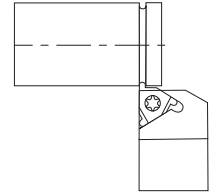
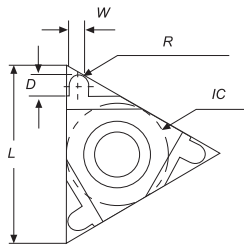

Inserts ER = IL

Order code Código	Reference Referência Referencia	Anvil	Dimensions Dimensões Dimensiones (mm)					Stock - Grade Code (2)	
			IC	L	W	R	D	(68) PH6920	(D0) PH8920
1881149	16 ER R 0.50	EA 16	9,525	16	1,00	0,50	1,40	☉	○
1883732	16 ER R 0.60	EA 16	9,525	16	1,20	0,60	1,60	○	○
1883733	16 ER R 0.90	EA 16	9,525	16	1,80	0,90	2,00	○	○
1881151	16 ER R 1.00	EA 16	9,525	16	2,00	1,00	2,00	○	○
1883734	16 ER R 1.10	EA 16	9,525	16	2,20	1,10	2,15	○	○
1883735	16 ER R 1.20	EA 16	9,525	16	2,40	1,20	2,15	○	○

☉ Stock item | Produto de stock | Itens de stock

○ Available under request | Disponível sobre consulta
Disponível bajo consulta

Insert order code = (1) Geometry Code + (2) Grade Code

Note: Select the toolholder "SXAN"



Internal

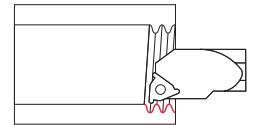
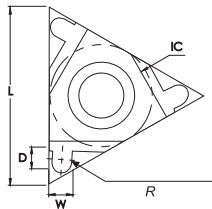

Inserts IR = EL

Order code Código	Reference Referência Referencia	Anvil	Dimensions Dimensões Dimensiones (mm)					Stock - Grade Code (2)	
			IC	L	W	R	D	(68) PH6920	(D0) PH8920
1881145	16 IR R 0.50	EA 16	9,525	16	1,00	0,50	1,40	○	○
1883736	16 IR R 0.60	EA 16	9,525	16	1,20	0,60	1,60	○	○
1883737	16 IR R 0.90	EA 16	9,525	16	1,80	0,90	2,00	○	○
1881147	16 IR R 1.00	EA 16	9,525	16	2,00	1,00	2,00	○	○
1883738	16 IR R 1.10	EA 16	9,525	16	2,20	1,10	2,15	○	○
1883739	16 IR R 1.20	EA 16	9,525	16	2,40	1,20	2,15	○	○

☉ Stock item | Produto de stock | Itens de stock

○ Available under request | Disponível sobre consulta
Disponível bajo consulta

Insert order code = (1) Geometry Code + (2) Grade Code

Note: Select the toolholder "SXFN"

EXTERNAL TOOLHOLDERS CODE KEY

Chave de codificação para suporte externos | Llave de codificación para herramienta exterior

S	X	A	N
1	2	3	4

R
5

25
6

25
7

M
8

16
9

1 - Inserts Clamping System

C	D	M	P	S

2 - Insert Shape

C	D	E	K
R	S	T	V
X	W		

4 - Inserts Clearance Angle

B	C	N	P

5 - Tool Hand

R	L	N

3 - Toolholder Leading Angle

A	B	C
D	E	F
G	H	J
K	L	M
N	Q	R
S	T	V
X	Z	

6 - Height of Shank (mm)

H1

7 - Width of Shank (mm)

B

8 - Length of Holder (mm)

	D	60	P	170
	E	70	R	200
	F	80	S	250
	H	100	T	300
	K	125	U	350
	L	140	V	400
	M	150	X	Special

9 - Length of Inserts Cutting Edge (mm)

C, D, E, V	K	R	S
T	W	X	Z

D
GROOVING & PARTING OFF
Grooving Plus
Grooving & Parting Off
SAL - Swiss Automatic Lathes
Light Grooving
Forming Grooving
Technical Data

SXAN



External Left

Order Code Código	Reference Referência Referencia	Insert Geometry	Dimensions Dimensões Dimensiones (mm)				Anvil	Anvil Screw	Insert Screw	Torx Key	Stock
			H=h1	b	S	L					
182014600	SXAN L 0808 H11	11 EL	8	8	11	100	-	-	P0260700	XT08	○
182006900	SXAN L 1010 H11	11 EL	10	10	11	100	-	-	P0260700	XT08	⊗
182015600	SXAN L 1212 K11	11 EL	12	12	12	125	-	-	P0260700	XT08	○
182015700	SXAN L 1212 F16	16 EL	12	12	16	80	IA16	P5000790	P5401390	XT10	○
182011600	SXAN L 1616 H16	16 EL	16	16	16	100	IA16	P5000790	P5401390	XT10	○
182003700	SXAN L 2020 K16	16 EL	20	20	20	125	IA16	P5000790	P5401390	XT10	⊗
182003100	SXAN L 2525 M16	16 EL	25	25	25	150	IA16	P5000790	P5401390	XT10	⊗
182011700	SXAN L 3232 P16	16 EL	32	32	32	170	IA16	P5000790	P5401390	XT10	○

⊗ Stock item | Produto de stock | Itens de stock

○ Available under request | Disponível sobre consulta | Disponible bajo consulta

External Right

Order Code Código	Reference Referência Referencia	Insert Geometry	Dimensions Dimensões Dimensiones (mm)				Anvil	Anvil Screw	Insert Screw	Torx Key	Stock
			H=h1	b	S	L					
182014900	SXAN R 0808 H11	11 ER	8	8	10	100	-	-	P0260700	XT08	○
182007000	SXAN R 1010 H11	11 ER	10	10	10	100	-	-	P0260700	XT08	⊗
182016000	SXAN R 1212 K11	11 ER	12	12	12	125	-	-	P0260700	XT08	○
182003200	SXAN R 1212 F16	16 ER	12	12	16	80	EA16	P5000790	P5401390	XT10	⊗
182003300	SXAN R 1616 H16	16 ER	16	16	16	100	EA16	P5000790	P5401390	XT10	⊗
182004800	SXAN R 2020 K16	16 ER	20	20	20	125	EA16	P5000790	P5401390	XT10	⊗
182004900	SXAN R 2525 M16	16 ER	25	25	25	150	EA16	P5000790	P5401390	XT10	⊗
182005400	SXAN R 3232 P16	16 ER	32	32	32	170	EA16	P5000790	P5401390	XT10	⊗

⊗ Stock item | Produto de stock | Itens de stock

○ Available under request | Disponível sobre consulta | Disponible bajo consulta

INTERNAL TOOLHOLDERS CODE KEY

Chave de codificação para suporte internos | Llave de codificación para herramienta interior

S	32	S	S	X	F	N	R	16
1	2	3	4	5	6	7	8	9

1 - Bar Type

S	Steel shank
----------	-------------

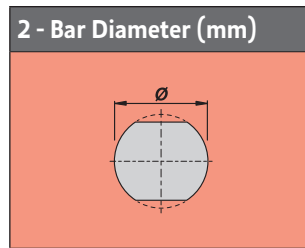

3 - Bar Length (mm)

H	100	T	300
J	110	U	350
K	125	V	400
L	140	W	450
M	150	Y	500
Q	180	X	Special
R	200		
S	250		

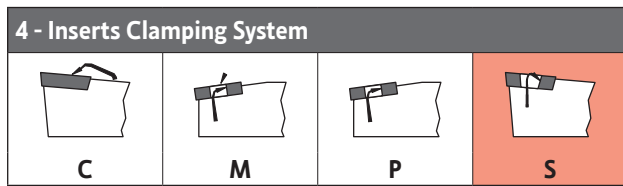

5 - Insert Shape

80° C	55° D	75° E	55° K
90° S	60° T	35° V	80° W
60° X			

6 - Bar Leading Angle

90° F	75° K	95° L
107°30' Q	93° U	93° U-BT
90° G		

7 - Inserts Clearance Angle

5° B	7° C	0° N	11° P
----------------	----------------	----------------	-----------------

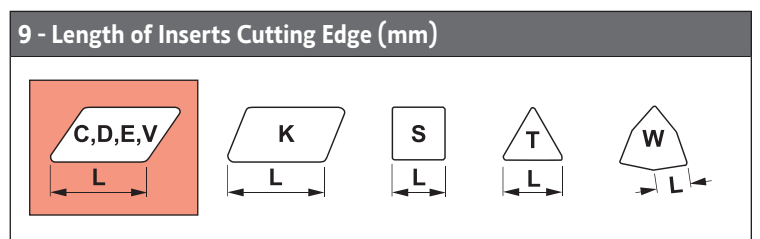
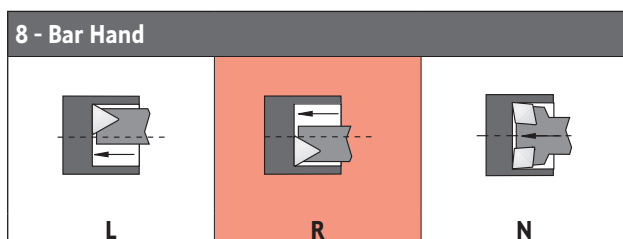

D GROOVING & PARTING OFF Grooving Plus Grooving & Parting Off SAL - Swiss Automatic Lathes Light Grooving Forming Grooving Technical Data

SXFN

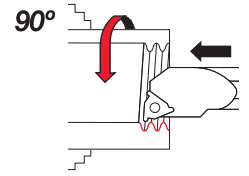
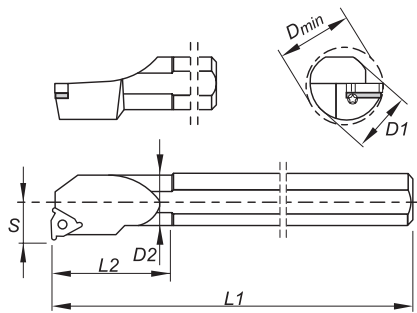

Internal Left

Order Code Código	Reference Referência Referencia	Insert Type	Dimensions Dimensões Dimensiones (mm)						Anvil	Anvil Screw	Insert Screw	Torx Key	Stock
			D1	D2	Dmin	L1	L2	S					
182006100	S10H SXFN L 11	11 IL	10	10	12	100	-	7,4	-	-	P0260700	XT08	⊗
182014300	S10K SXFN L 11	11 IL	16	10	12	125	25	7,4	-	-	P0260700	XT08	○
182016300	S13L SXFN L 11	11 IL	16	13	15	140	32	8,9	-	-	P0260700	XT08	○
182006300	S13M SXFN L 16	16 IL	16	13	16	150	32	10,2	-	-	P5401391	XT10	○
182006000	S16P SXFN L 16	16 IL	20	16	19	170	40	11,7	-	-	P5401391	XT10	⊗
182002600	S20P SXFN L 16	16 IL	20	20	24	170	-	13,7	EA16	P5000790	P5401390	XT10	⊗
182005500	S25R SXFN L 16	16 IL	25	25	29	200	-	16,2	EA16	P5000790	P5401390	XT10	⊗
182012500	S32S SXFN L 16	16 IL	32	32	36	250	-	19,7	EA16	P5000790	P5401390	XT10	○
182012700	S40T SXFN L 16	16 IL	40	40	44	300	-	23,7	EA16	P5000790	P5401390	XT10	○

⊗ Stock item | Produto de stock
Itens de stock

○ Available under request | Disponível sobre consulta
Disponível bajo consulta

Note: All the toolholders SXFN are made with 1,5° helix angle. | Todos os ferros de torno são fornecidos com um ângulo de hélice de 1,5° | Todos los soportes se hacen con un ángulo de hélice de 1,5°.

Internal Right

Order Code Código	Reference Referência Referencia	Insert Type	Dimensions Dimensões Dimensiones (mm)						Anvil	Anvil Screw	Insert Screw	Torx Key	Stock
			D1	D2	Dmin	L1	L2	S					
182002100	S10H SXFN R 11	11 IR	10	10	12	100	-	7,4	-	-	P0260700	XT08	⊗
182006200	S10K SXFN R 11	11 IR	16	10	12	125	25	7,4	-	-	P0260700	XT08	○
182016400	S10L SXFN R 11	11 IR	16	13	15	140	32	8,9	-	-	P0260700	XT08	○
182002300	S13M SXFN R 16	16 IR	16	13	16	150	32	10,2	-	-	P5401391	XT10	○
182002500	S16P SXFN R 16	16 IR	20	16	19	170	40	11,7	-	-	P5401391	XT10	⊗
182002700	S20P SXFN R 16	16 IR	20	20	24	170	-	13,7	IA16	P5000790	P5401390	XT10	⊗
182002900	S25R SXFN R 16	16 IR	25	25	29	200	-	16,2	IA16	P5000790	P5401390	XT10	⊗
182005600	S32S SXFN R 16	16 IR	32	32	36	250	-	19,7	IA16	P5000790	P5401390	XT10	○
182012600	S40T SXFN R 16	16 IR	40	40	44	300	-	23,7	IA16	P5000790	P5401390	XT10	○

⊗ Stock item | Produto de stock
Itens de stock

○ Available under request | Disponível sobre consulta
Disponível bajo consulta

Note: All the toolholders SXFN are made with 1,5° helix angle. | Todos os ferros de torno são fornecidos com um ângulo de hélice de 1,5° | Todos los soportes se hacen con un ángulo de hélice de 1,5°.

MAIN APPLICATIONS | Aplicações principais | Aplicaciones principales

GROOVING & PARTING OFF

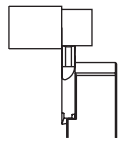

Turning

INSERTS

4 Different operations:

- Turning
- Parting off
- Grooving
- Threading

TOOLHOLDERS

Dimensions:

- 08x08mm
- 10x10mm
- 12x12mm
- 16x16mm

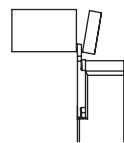
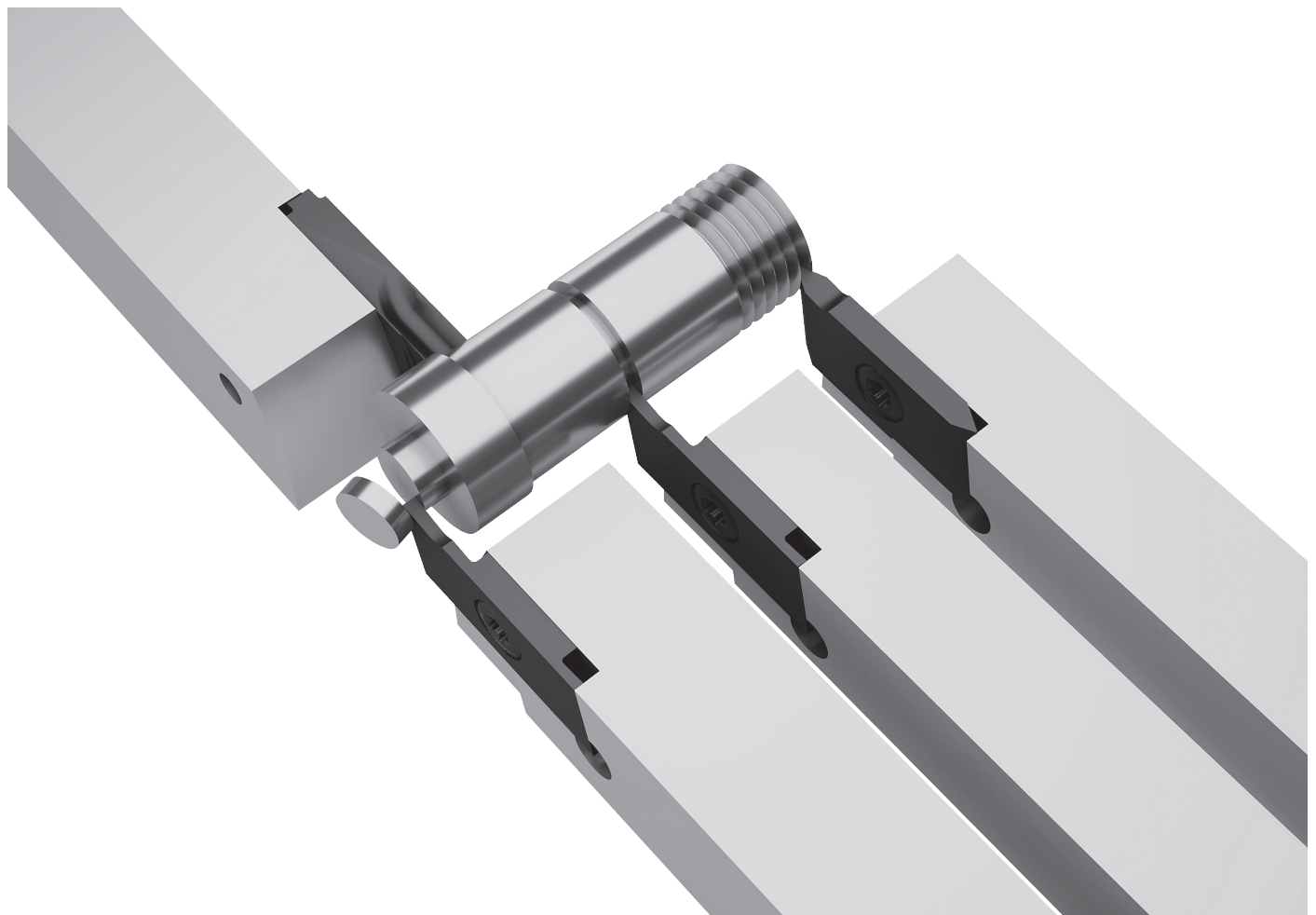

Parting off

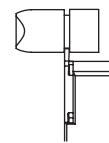

Grooving

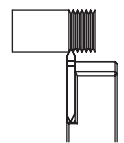

Threading

Grooving Plus

Grooving & Parting Off

SAL - Swiss Automatic Lathes

Light Grooving

Forming Grooving

Technical Data

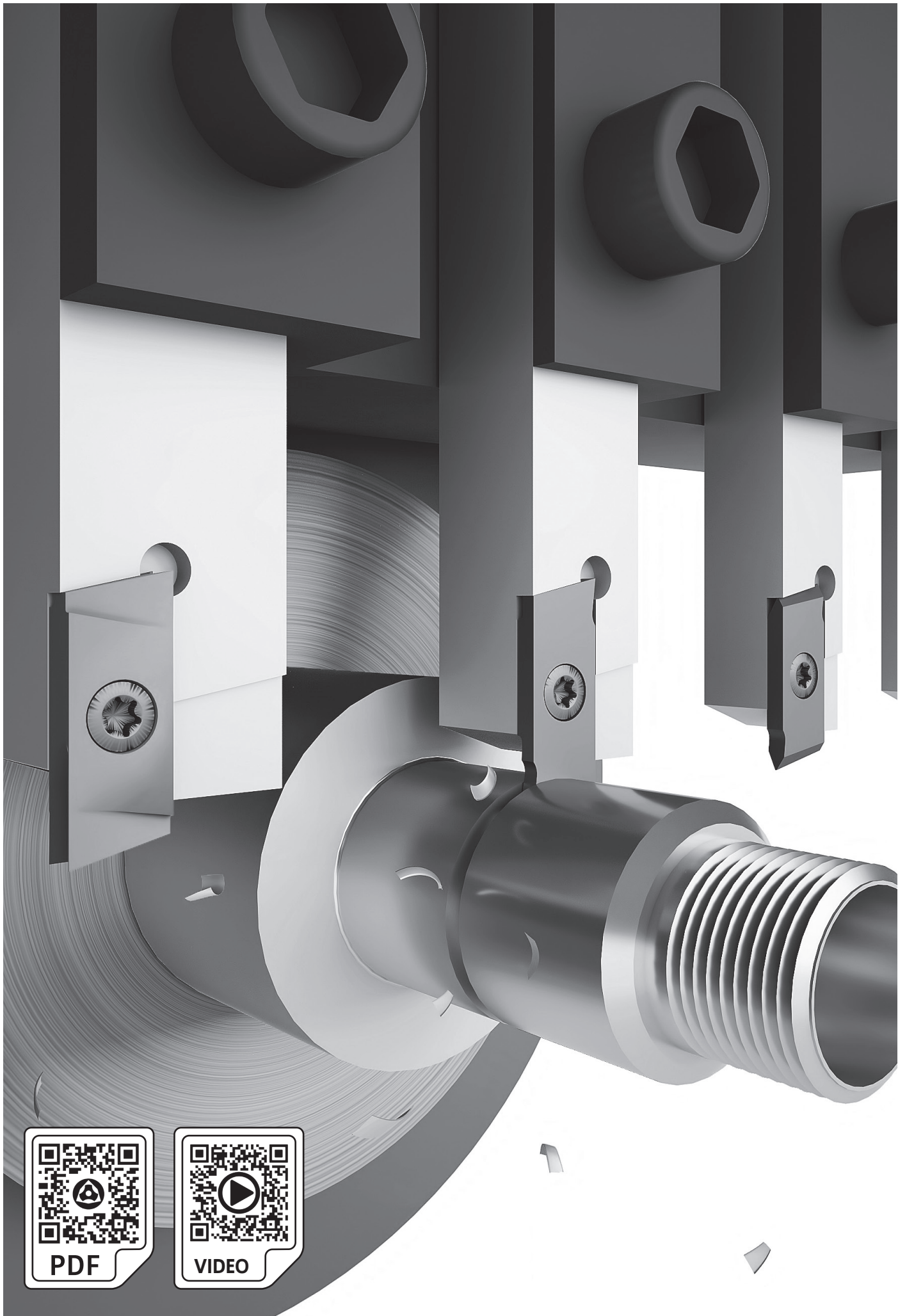

Technical Data

Forming Grooving

Light Grooving

SAL - Swiss Automatic Lathes

Grooving & Parting Off

Grooving Plus

GROOVING & PARTING OFF



SAL - SWISS AUTOMATIC LATHES

INSERTS CODE KEY - Chave de codificação para pastilhas | Llave de codificación de plaquitas

Grooving Inserts

SAL	25	G	050	R			GS
1	2	5	6	8	-		11

Parting Off Inserts

SAL	11	P	100	R	N		P07
1	3	5	6	8	9	-	11

Threading Inserts

SAL	100	H	010	R	60		PT
1	4	5	7	8	10	-	11

Turning Inserts

SAL	60	T	300	R			TP
1	2	5	6	8	-		11

1 - Product line

SAL - Swiss Automatic Lathes Line

2 - Maximum depth of cut (Turning and Grooving inserts)

25 - 2,5mm | 60 - 6,0mm

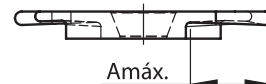

3 - Maximum Cutting Diameter (Parting Off Inserts)

11 - 11,0mm | 13 - 13,0mm

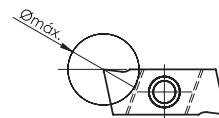

4 - Center distance (Threading Inserts)

050 - 0,5mm | 100 - 1,00mm

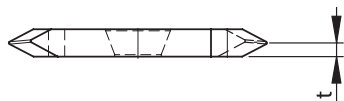

5 - Operations type

G - Grooving

P - Parting off

H - Threading

T - Turning

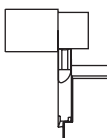
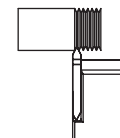
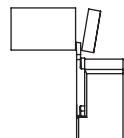
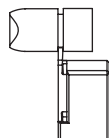

6 - Cut thickness (Grooving, Parting Off and Turning Inserts)

050 - 0,50mm | 070 - 0,70mm | 080 - 0,80mm
090 - 0,90mm | 100 - 1,00mm | 110 - 1,10mm
130 - 1,30mm | 150 - 1,50mm | 160 - 1,60mm
185 - 1,85mm | 200 - 2,00 mm | 300 - 3,00 mm

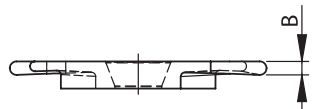

7 - Corner radius (Threading Inserts)

005 - 0,05mm | 010 - 0,10mm
012 - 0,12mm

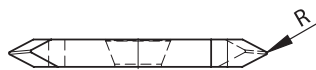

8 - Insert / toolholder side

L - Left hand

R - Right hand



9 - Front angle (Parting off)

N - Neutral

R - Right

L - Left



10 - Angle (Threading Inserts)

55 - 55° | 60 - 60°

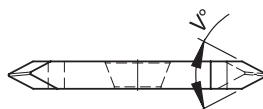

11 - Chip Breaker (Turning, Grooving, Parting Off and Threading Inserts)

Turning

TP - Turning steel

Grooving

GS - Square Grooving
GR - Round Grooving

Parting Off

P00 - Front angle 0°
P07 - Front angle 7°

Threading

PT - Partial Profile

TOOLHOLDERS CODE KEY - Chave de codificação para suportes | Llave de codificación de herramienta

SAL	H	E	R	-	08	08	-	M	07
1	2	3	4		5	6		7	8

1 - Product line
SAL - Swiss Automatic Lathes Line
2 - Tool type
H - Holder
3 - Internal or External
E - External

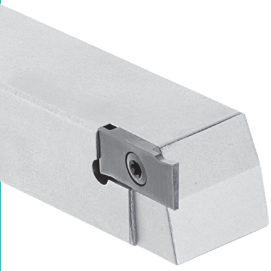
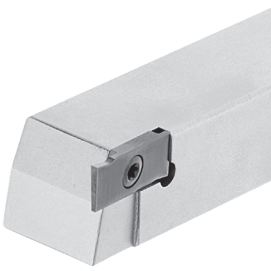
4 - Insert / toolholder side	
L - Left hand	R - Right hand
	

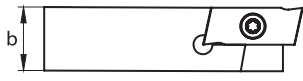
5 - Shank height
08 - 8 mm
10 - 10 mm
12 - 12 mm
16 - 16 mm

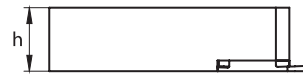
6 - Shank width
08 - 8 mm
10 - 10 mm
12 - 12 mm
16 - 16 mm

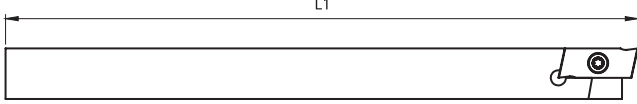
7 - Shank length (mm)
L - 140 mm
M - 150 mm

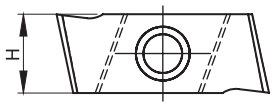
8 - Insert cutting edge length (mm)
07 - 7,0 mm

SAL - SWISS AUTOMATIC LATHES

EXTERNAL TOOLHOLDERS | Suportes exteriores | herramientas de tronzado exterior



Left hand style show

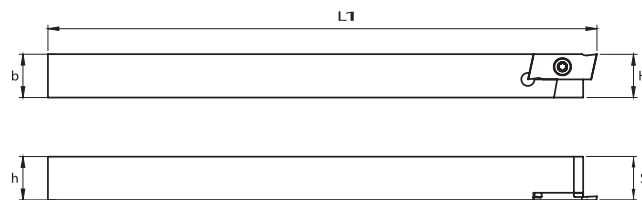

Order code Código	Reference Referência Referencia	Dimensions Dimensões Dimensiones (mm)					* Insert	Screw	Wrench	Stock
		h	b	H	L1	S				
213023600	SALHEL 0808 M07	8,00	8,00	8,00	150,00	8,00	SAL...L	P0300900	XT 08	☺
213023700	SALHEL 1010 M07	10,00	10,00	10,00	150,00	10,00	SAL...L	P0300900	XT 08	☺
213023800	SALHEL 1212 M07	12,00	12,00	12,00	150,00	12,00	SAL...L	P0300900	XT 08	☺
213023900	SALHEL 1616 M07	16,00	16,00	16,00	150,00	16,00	SAL...L	P0300900	XT 08	☺
213029700	SALHEL 2020 M07	20,00	20,00	20,00	150,00	20,00	SAL...L	P0300900	XT 08	☺
213029900	SALHEL 2525 M07	25,00	25,00	25,00	150,00	25,00	SAL...L	P0300900	XT 08	☺

☺ Stock item | Produto de stock | Itens de stock

○ Available under request | Disponível sobre consulta | Disponible bajo consulta

* Left insert only fits on left toolholder



Right hand style show

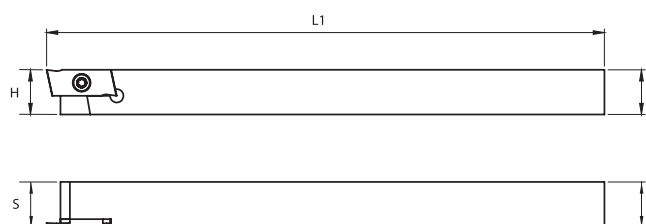

Order code Código	Reference Referência Referencia	Dimensions Dimensões Dimensiones (mm)					* Insert	Screw	Wrench	Stock
		h	b	H	L1	S				
213023200	SALHER 0808 M07	8,00	8,00	8,00	150,00	8,00	SAL...R	P0300900	XT 08	☺
213023300	SALHER 1010 M07	10,00	10,00	10,00	150,00	10,00	SAL...R	P0300900	XT 08	☺
213023400	SALHER 1212 M07	12,00	12,00	12,00	150,00	12,00	SAL...R	P0300900	XT 08	☺
213023500	SALHER 1616 M07	16,00	16,00	16,00	150,00	16,00	SAL...R	P0300900	XT 08	☺
213029600	SALHER 2020 M07	20,00	20,00	20,00	150,00	20,00	SAL...R	P0300900	XT 08	☺
213029800	SALHER 2525 M07	25,00	25,00	25,00	150,00	25,00	SAL...R	P0300900	XT 08	☺

☺ Stock item | Produto de stock | Itens de stock

○ Available under request | Disponível sobre consulta | Disponible bajo consulta

* Right insert only fits on right toolholder

GS SERIES | Inserts | Pastilhas | Plaquetas

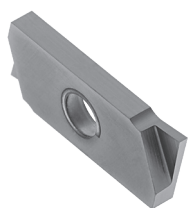

Right hand style show

For square grooving
Para grooving quadrado
Para ranurado quadrado

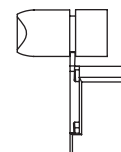
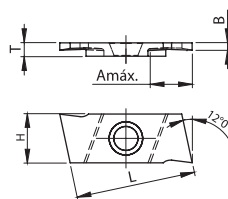

Grooving

(1) Geometry code	(2) Grade code		PVD								Dimensions (mm) Dimensões (mm) Dimensiones (mm)						Cutting conditions Condições de corte Condiciones de corte			
			P		M		K		S		B	L	T	H	Amáx.	V°	Ømáx.	fn (mm/r)	Min.	Max.
			G1	G4	G4	P8	G4	P8	G4	P8										
1130441	SAL25G050R-GS	SAL25G050R-GS	○	⊗	⊗	○	⊗	○	⊗	○	0,50	17,00	2,00	7,00	2,50	-	-	0,04	0,02	0,06
1130475	SAL25G070R-GS	SAL25G070R-GS	○	⊗	⊗	○	⊗	○	⊗	○	0,70	17,00	2,00	7,00	2,50	-	-	0,05	0,02	0,08
1130477	SAL25G080R-GS	SAL25G080R-GS	○	⊗	⊗	○	⊗	○	⊗	○	0,80	17,00	2,00	7,00	2,50	-	-	0,05	0,02	0,09
1130479	SAL25G090R-GS	SAL25G090R-GS	○	⊗	⊗	○	⊗	○	⊗	○	0,90	17,00	2,00	7,00	2,50	-	-	0,06	0,02	0,10
1130488	SAL60G110R-GS	SAL60G110R-GS	○	⊗	⊗	○	⊗	○	⊗	○	1,10	17,00	2,00	7,00	6,00	-	-	0,06	0,02	0,11
1130490	SAL60G130R-GS	SAL60G130R-GS	○	⊗	⊗	○	⊗	○	⊗	○	1,30	17,00	2,00	7,00	6,00	-	-	0,07	0,02	0,12
1130442	SAL60G160R-GS	SAL60G160R-GS	○	⊗	⊗	○	⊗	○	⊗	○	1,60	17,00	2,00	7,00	6,00	-	-	0,07	0,02	0,13
1130495	SAL60G185R-GS	SAL60G185R-GS	○	⊗	⊗	○	⊗	○	⊗	○	1,85	17,00	2,00	7,00	6,00	-	-	0,08	0,02	0,14
1130473	SAL25G050L-GS	SAL25G050L-GS	○	⊗	⊗	○	⊗	○	⊗	○	0,50	17,00	2,00	7,00	2,50	-	-	0,04	0,02	0,06
1130474	SAL25G070L-GS	SAL25G070L-GS	○	⊗	⊗	○	⊗	○	⊗	○	0,70	17,00	2,00	7,00	2,50	-	-	0,05	0,02	0,08
1130476	SAL25G080L-GS	SAL25G080L-GS	○	⊗	⊗	○	⊗	○	⊗	○	0,80	17,00	2,00	7,00	2,50	-	-	0,05	0,02	0,09
1130478	SAL25G090L-GS	SAL25G090L-GS	○	⊗	⊗	○	⊗	○	⊗	○	0,90	17,00	2,00	7,00	2,50	-	-	0,06	0,02	0,10
1130487	SAL60G110L-GS	SAL60G110L-GS	○	⊗	⊗	○	⊗	○	⊗	○	1,10	17,00	2,00	7,00	6,00	-	-	0,06	0,02	0,11
1130489	SAL60G130L-GS	SAL60G130L-GS	○	⊗	⊗	○	⊗	○	⊗	○	1,30	17,00	2,00	7,00	6,00	-	-	0,07	0,02	0,12
1130493	SAL60G160L-GS	SAL60G160L-GS	○	⊗	⊗	○	⊗	○	⊗	○	1,60	17,00	2,00	7,00	6,00	-	-	0,07	0,02	0,13
1130494	SAL60G185L-GS	SAL60G185L-GS	○	⊗	⊗	○	⊗	○	⊗	○	1,85	17,00	2,00	7,00	6,00	-	-	0,08	0,02	0,14

⊗ Stock item | Produto de stock | Itens de stock

○ Available under request with delivery time 4 weeks
Disponível sobre consulta com prazo de entrega de 4 semanas
Disponible bajo consulta, con fecha de entrega en 4 semanas

Order code = (1) Geometry code + (2) Grade code

GR SERIES | Inserts | Pastilhas | Plaquetas

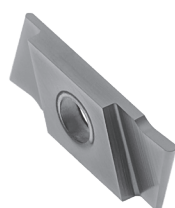

Right hand style show

For round grooving
Para grooving redondo
Para ranurado redondo

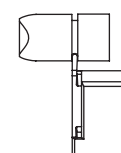
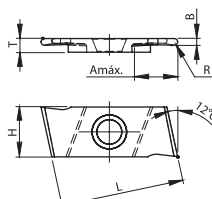

Grooving

(1) Geometry code	(2) Grade code		PVD								Dimensions (mm) Dimensões (mm) Dimensiones (mm)						Cutting conditions Condições de corte Condiciones de corte			
			P		M		K		S		B	L	T	H	Amáx.	V°	Ømáx.	fn (mm/r)	Min.	Max.
			G1	G4	G4	P8	G4	P8	G4	P8										
1130443	SAL60G100R-GR	SAL60G100R-GR	○	⊗	⊗	○	⊗	○	⊗	○	1,00	17,00	2,00	7,00	6,00	-	-	0,06	0,02	0,10
1130492	SAL60G150R-GR	SAL60G150R-GR	○	⊗	⊗	○	⊗	○	⊗	○	1,50	17,00	2,00	7,00	6,00	-	-	0,08	0,02	0,12
1130497	SAL60G200R-GR	SAL60G200R-GR	○	⊗	⊗	○	⊗	○	⊗	○	2,00	17,00	2,00	7,00	6,00	-	-	0,08	0,03	0,14
1130486	SAL60G100L-GR	SAL60G100L-GR	○	⊗	⊗	○	⊗	○	⊗	○	1,00	17,00	2,00	7,00	6,00	-	-	0,06	0,02	0,10
1130491	SAL60G150L-GR	SAL60G150L-GR	○	⊗	⊗	○	⊗	○	⊗	○	1,50	17,00	2,00	7,00	6,00	-	-	0,08	0,02	0,12
1130496	SAL60G200L-GR	SAL60G200L-GR	○	⊗	⊗	○	⊗	○	⊗	○	2,00	17,00	2,00	7,00	6,00	-	-	0,08	0,03	0,14

⊗ Stock item | Produto de stock | Itens de stock

○ Available under request with delivery time 4 weeks
Disponível sobre consulta com prazo de entrega de 4 semanas
Disponible bajo consulta, con fecha de entrega en 4 semanas

Order code = (1) Geometry code + (2) Grade code

SAL - SWISS AUTOMATIC LATHES

P(P00) SERIES | Inserts | Pastilhas | Plaquetas

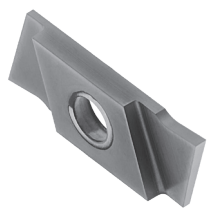

Right hand style show

Without front angle
Sem ângulo frontal
Sin ángulo frontal

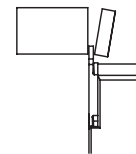
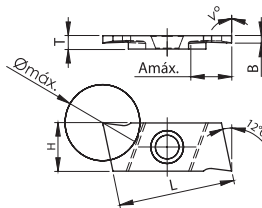

Parting off

(1) Geometry code	ISO Reference	ANSI Reference	PVD								Dimensions (mm) Dimensões (mm) Dimensiones (mm)						Cutting conditions Condições de corte Condiciones de corte			
			(2) Grade code								B	L	T	H	Amáx.	V°	Ømáx.	fn (mm/r)	Min.	Max.
			G1	G4	G4	P8	G4	P8	G4	P8										
			PH7910	PH7920	PH7920	PH7135	PH7920	PH7135	PH7920	PH7135										
1130444	SAL11P100RN-P00	SAL11P100RN-P00	○	⊗	⊗	○	⊗	○	⊗	○	1,00	17,00	2,00	7,00	6,00	0	11,00	0,06	0,02	0,10
1130462	SAL11P150RN-P00	SAL11P150RN-P00	○	⊗	⊗	○	⊗	○	⊗	○	1,50	17,00	2,00	7,00	6,00	0	11,00	0,08	0,02	0,12
1130468	SAL13P200RN-P00	SAL13P200RN-P00	○	⊗	⊗	○	⊗	○	⊗	○	2,00	17,00	2,00	7,00	6,00	0	13,00	0,08	0,03	0,14
1130456	SAL11P100LN-P00	SAL11P100LN-P00	○	⊗	⊗	○	⊗	○	⊗	○	1,00	17,00	2,00	7,00	6,00	0	11,00	0,06	0,02	0,10
1130459	SAL11P150LN-P00	SAL11P150LN-P00	○	⊗	⊗	○	⊗	○	⊗	○	1,50	17,00	2,00	7,00	6,00	0	11,00	0,08	0,02	0,12
1130465	SAL13P200LN-P00	SAL13P200LN-P00	○	⊗	⊗	○	⊗	○	⊗	○	2,00	17,00	2,00	7,00	6,00	0	13,00	0,08	0,03	0,14

⊗ Stock item | Produto de stock | Itens de stock

○ Available under request with delivery time 4 weeks
Disponível sobre consulta com prazo de entrega de 4 semanas
Disponible bajo consulta, con fecha de entrega en 4 semanas

Order code = (1) Geometry code + (2) Grade code

P(P07) SERIES | Inserts | Pastilhas | Plaquetas

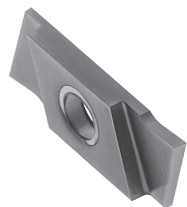

Right hand style show

Front angle 7°
Ângulo frontal de 7°
Angulo frontal de 7°

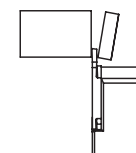
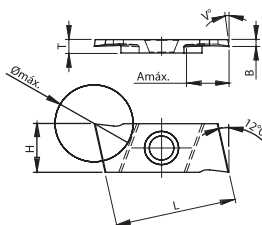

Parting off

(1) Geometry code	ISO Reference	ANSI Reference	PVD								Dimensions (mm) Dimensões (mm) Dimensiones (mm)						Cutting conditions Condições de corte Condiciones de corte			
			(2) Grade code								B	L	T	H	Amáx.	V°	Ømáx.	fn (mm/r)	Min.	Max.
			G1	G4	G4	P8	G4	P8	G4	P8										
			PH7910	PH7920	PH7920	PH7135	PH7920	PH7135	PH7920	PH7135										
1130445	SAL11P100RR-P07	SAL11P100RR-P07	○	⊗	⊗	○	⊗	○	⊗	○	1,00	17,00	2,00	7,00	6,00	7	11,00	0,05	0,02	0,08
1130446	SAL11P100RL-P07	SAL11P100RL-P07	○	⊗	⊗	○	⊗	○	⊗	○	1,00	17,00	2,00	7,00	6,00	7	11,00	0,05	0,02	0,08
1130463	SAL11P150RR-P07	SAL11P150RR-P07	○	⊗	⊗	○	⊗	○	⊗	○	1,50	17,00	2,00	7,00	6,00	7	11,00	0,06	0,02	0,10
1130461	SAL11P150RL-P07	SAL11P150RL-P07	○	⊗	⊗	○	⊗	○	⊗	○	1,50	17,00	2,00	7,00	6,00	7	11,00	0,06	0,02	0,10
1130469	SAL13P200RR-P07	SAL13P200RR-P07	○	⊗	⊗	○	⊗	○	⊗	○	2,00	17,00	2,00	7,00	6,00	7	13,00	0,06	0,03	0,12
1130467	SAL13P200RL-P07	SAL13P200RL-P07	○	⊗	⊗	○	⊗	○	⊗	○	2,00	17,00	2,00	7,00	6,00	7	13,00	0,06	0,03	0,12
1130457	SAL11P100LR-P07	SAL11P100LR-P07	○	⊗	⊗	○	⊗	○	⊗	○	1,00	17,00	2,00	7,00	6,00	7	11,00	0,05	0,02	0,08
1130455	SAL11P100LL-P07	SAL11P100LL-P07	○	⊗	⊗	○	⊗	○	⊗	○	1,00	17,00	2,00	7,00	6,00	7	11,00	0,05	0,02	0,08
1130460	SAL11P150LR-P07	SAL11P150LR-P07	○	⊗	⊗	○	⊗	○	⊗	○	1,50	17,00	2,00	7,00	6,00	7	11,00	0,06	0,02	0,10
1130458	SAL11P150LL-P07	SAL11P150LL-P07	○	⊗	⊗	○	⊗	○	⊗	○	1,50	17,00	2,00	7,00	6,00	7	11,00	0,06	0,02	0,10
1130466	SAL13P200LR-P07	SAL13P200LR-P07	○	⊗	⊗	○	⊗	○	⊗	○	2,00	17,00	2,00	7,00	6,00	7	13,00	0,06	0,03	0,12
1130464	SAL13P200LL-P07	SAL13P200LL-P07	○	⊗	⊗	○	⊗	○	⊗	○	2,00	17,00	2,00	7,00	6,00	7	13,00	0,06	0,03	0,12

⊗ Stock item | Produto de stock | Itens de stock

○ Available under request with delivery time 4 weeks
Disponível sobre consulta com prazo de entrega de 4 semanas
Disponible bajo consulta, con fecha de entrega en 4 semanas

Order code = (1) Geometry code + (2) Grade code

PT SERIES | Inserts | Pastilhas | Plaquetas

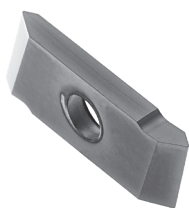

Right hand style show

For partial profile threading
Para perfil parcial de roscagem
Para perfil parcial de roscado

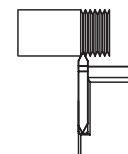
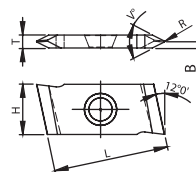

Threading

(1) Geometry code	(2) Grade code		PVD								Dimensions (mm) Dimensões (mm) Dimensiones (mm)						Cutting conditions Condições de corte Condiciones de corte			
			P		M		K		S		B	L	T	H	Amáx.	V°	Ømáx.	fn (mm/r)	Min.	Max.
			G1	G4	G4	P8	G4	P8	G4	P8										
1130472	SAL100H012R55-PT	SAL100H012R55-PT	○	⊗	⊗	○	⊗	○	⊗	○	1,09	1700	2,00	7,00	0,12	55	-	0,80	0,20	2,00
1130447	SAL100H012R60-PT	SAL100H012R60-PT	○	⊗	⊗	○	⊗	○	⊗	○	1,09	1700	2,00	7,00	0,12	60	-	0,80	0,20	2,00
1130470	SAL100H012L55-PT	SAL100H012L55-PT	○	⊗	⊗	○	⊗	○	⊗	○	1,09	1700	2,00	7,00	0,12	55	-	0,80	0,20	2,00
1130471	SAL100H012L60-PT	SAL100H012L60-PT	○	⊗	⊗	○	⊗	○	⊗	○	1,09	1700	2,00	7,00	0,12	60	-	0,80	0,20	2,00

⊗ Stock item | Produto de stock | Itens de stock

○ Available under request with delivery time 4 weeks
Disponível sobre consulta com prazo de entrega de 4 semanas
Disponible bajo consulta, con fecha de entrega en 4 semanas

Order code = (1) Geometry code + (2) Grade code

TP SERIES | Inserts | Pastilhas | Plaquetas

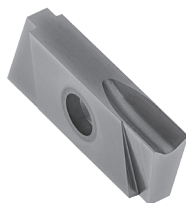

Right hand style show

For turning
Para torneamento
Para torneado

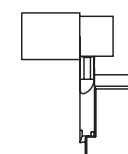
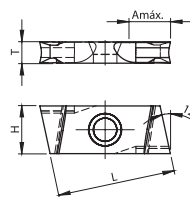

Turning

(1) Geometry code	(2) Grade code		PVD								Dimensions (mm) Dimensões (mm) Dimensiones (mm)						Cutting conditions Condições de corte Condiciones de corte			
			P		M		K		S		B	L	T	H	Amáx.	V°	Ømáx.	fn (mm/r)	Min.	Max.
			G1	G4	G4	P8	G4	P8	G4	P8										
1130501	SAL60T300R-TP	SAL60T300R-TP	○	⊗	⊗	○	⊗	○	⊗	○	-	1700	3,17	7,00	6,00	-	-	0,08	0,02	0,12
1130499	SAL60T300L-TP	SAL60T300L-TP	○	⊗	⊗	○	⊗	○	⊗	○	-	1700	3,17	7,00	6,00	-	-	0,08	0,02	0,12

⊗ Stock item | Produto de stock | Itens de stock

○ Available under request with delivery time 4 weeks
Disponível sobre consulta com prazo de entrega de 4 semanas
Disponible bajo consulta, con fecha de entrega en 4 semanas

Order code = (1) Geometry code + (2) Grade code

BLANKS FOR GRINDING | Blanks para personalizar | Blanks para personalizar



Right hand style show

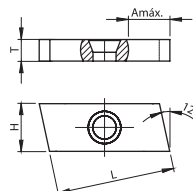

Inserts blanks “do it yourself” grinding are available allowing modifications of the insert for any machining operation.

As pastilhas de blank “faça você mesmo” permitem a personalização da pastilha para qualquer operação de maquinação.

Las plaquetas de blank “haga usted mismo” permiten la personalización de la plaqueta para cualquiera operación de maquinación.

(1) Geometry code	(2) Grade code		Uncoated			Dimensions (mm) Dimensões (mm) Dimensiones (mm)						
			10	12	14	B	L	T	H	Amáx.	V°	Ømáx.
			PH0910	PH0920	PH0135							
1130440	BLANK SALR 17x7x2	BLANK SALR 17x7x2	⊗	⊗	⊗	-	1750	2,00	750	-	-	-
1130504	BLANK SALR 17x7x3,17	BLANK SALR 17x7x3,17	⊗	⊗	⊗	-	1750	3,17	750	-	-	-
1130453	BLANK SALL 17x7x2	BLANK SALL 17x7x2	⊗	⊗	⊗	-	1750	2,00	750	-	-	-
1130505	BLANK SALL 17x7x3,17	BLANK SALL 17x7x3,17	⊗	⊗	⊗	-	1750	3,17	750	-	-	-

⊗ Stock item | Produto de stock | Itens de stock

○ Available under request | Disponível sobre consulta | Disponible bajo consulta

Order code = (1) Geometry code + (2) Grade code

SAL - SWISS AUTOMATIC LATHES

GROOVING | Canais | Ranurado

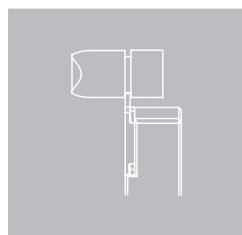

- High precision
- Close tolerances
- Wide variety of insert widths

GS

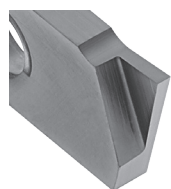

Square grooving

GR

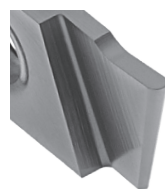

Round grooving

Recommended cutting conditions

P	M	K	S
60-200	60-180	60-150	20-50

Recommended grade PH7920, (Vc) m/min.

Grade PH7910 and PH7135

Available under request (4 weeks delivery time)

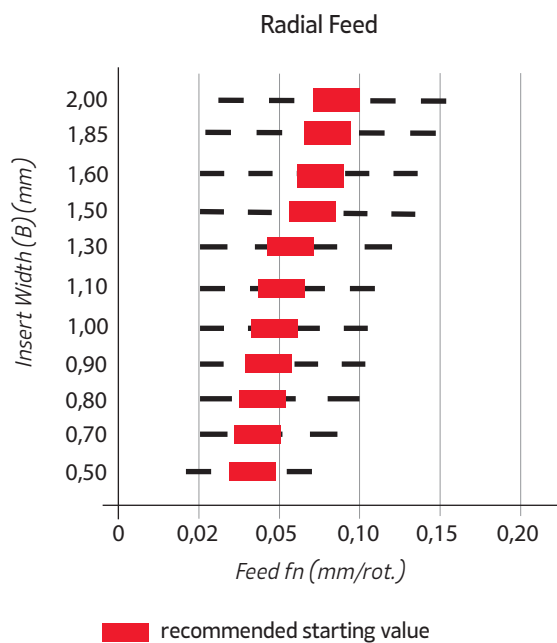

PARTING OFF | Corte | Tronzado

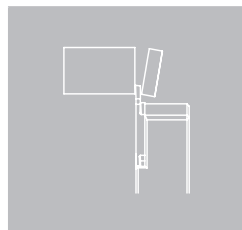

- When parting off with a sub-spindle, it is more productive to use a straight cutting edge. This is a more stable parting method and will generate the best surface finish.
- When parting off without a sub-spindle, we recommend you use an insert with a maximum 7° front angle to minimize the risk of burr and pips on the component.
- When parting off with 7° front angled inserts, we recommend reducing the feed rate by approximately 30%.

P00

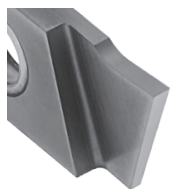

0° Relief angle

P07

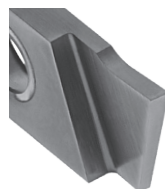

7° Relief angle

Recommended cutting conditions

P	M	K	S
60-200	60-180	60-150	20-50

Recommended grade PH7920, (Vc) m/min.

Grade PH7910 and PH7135

Available under request (4 weeks delivery time)

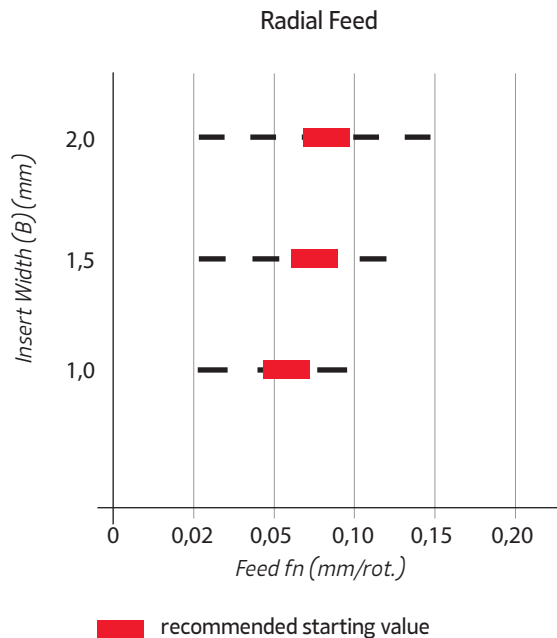

THREADING || Roscagem | Roscado

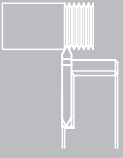

Two types of threading:

- Partial profile 55°
- Partial profile 60°

Pitch from 12 - 94 TPI / 0,25 - 2,0 mm

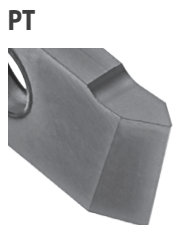

Partial profile

Recommended cutting conditions

P	M	K	S
60-200	60-180	60-150	20-50

Recommended grade PH7920, (Vc) m/min.

Grade PH7910 and PH7135

Available under request (4 weeks delivery time)

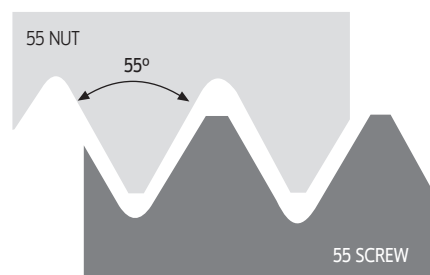
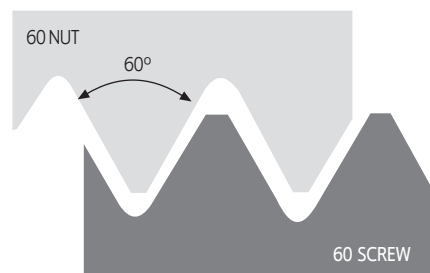

TURNING || Torneamento | Torneado

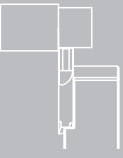

- Insert for turning
- Maximum deep of cut is 2,50 mm
- Too low cutting speed will result in inadequate tool life and it is advisable to follow cutting speed recommendations.

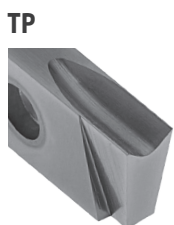

Turning steel

Recommended cutting conditions

P	M	K	S
60-200	60-180	60-150	20-50

Recommended grade PH7920, (Vc) m/min.

Grade PH7910 and PH7135

Available under request (4 weeks delivery time)

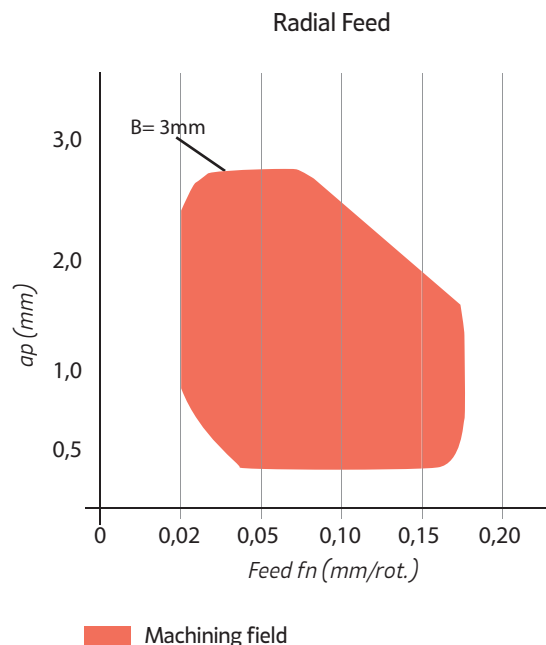

LIGHT GROOVING NEW



GROOVING & PARTING OFF

Grooving Plus

Grooving & Parting Off

SAL - Swiss Automatic Lathes

Light Grooving

Forming Grooving

Technical Data



INSERTS | Pastilhas | Plaquetas

LG	06	02	R	110
1	2	3	4	5

1 - Product Line Ligne de produits Produktlinie
LG - Light Grooving
2 - Insert size
06 - IC=6,35mm
3 - Cutting edges
02 - 2 cutting edges
4 - Work side
R - Right L - Left
5 - Edge width
110=1,1mm

TOOLHOLDERS | Suportes | Herramientas

LG	H	06	02	I	R	150	16
1	2	3	4	5	6	7	8

1 - Product Line
LG - Light Grooving
2 - Product type
H - Holder
3 - Insert size
06 - IC=6,35mm
4 - Cutting edges
02 - 2 Cutting edges
5 - Internal / External
I - Internal E - External
6 - Work side
R - Right L - Left
7 - Tool length
150 - 150mm
8 - Shank dimension
Internal: 16 - Ø16mm External: 2020 - 20mm x 20mm

LGH-ER/L

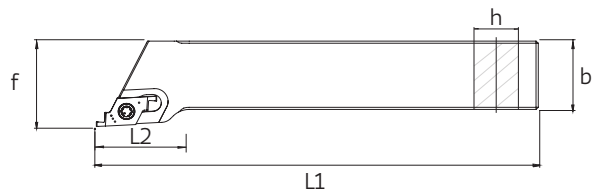

Order code Código	Reference Referência Referencia	Dimensions Dimensões Dimensiones (mm)					Insert	Stock
		h	b1	L1	L2	f		
Right Toolholder								
183031100	LGH 0602-ER 100 1616	16	16	100	21	20	LG 0602R	⊗
183031200	LGH 0602-ER 125 2020	20	20	125	25	25	LG 0602R	⊗
183031300	LGH 0602-ER 150 2525	25	25	150	32	32	LG 0602R	⊗
Left Toolholder								
183030300	LGH 0602-EL 100 1616	16	16	100	21	20	LG 0602L	⊗
183030400	LGH 0602-EL 125 2020	20	20	125	25	25	LG 0602L	⊗
183030500	LGH 0602-EL 150 2525	25	25	150	32	32	LG 0602L	⊗

⊗ Stock item | Produto de stock | Itens de stock ○ Available under request | Disponível sobre consulta | Disponible bajo consulta

LGH-IR/L

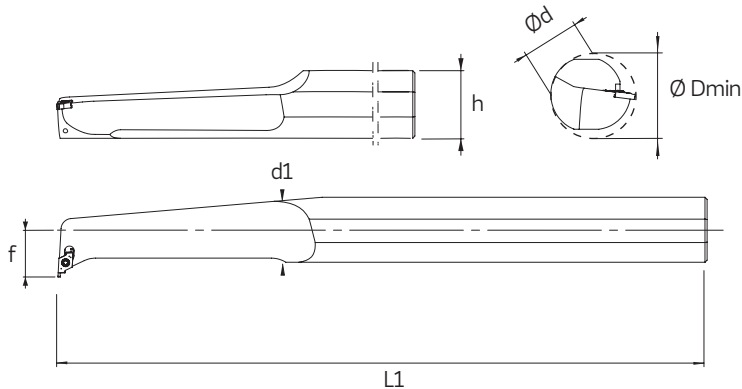

Order code Código	Reference Referência Referencia	Dimensions Dimensões Dimensiones (mm)					Insert	ØDmin	Stock
		Ød	h	d1	L1	f			
Right Toolholder									
183031400	LGH 0602-IR 150 12	12	11	11,5	150	9	LG 0602L	16	⊗
183031500	LGH 0602-IR 150 16	16	15	15	150	11	LG 0602L	20	⊗
183031600	LGH 0602-IR 170 20	20	18	19	170	13	LG 0602L	25	⊗
183031700	LGH 0602-IR 200 25	25	23	24	200	17	LG 0602L	32	⊗
183031800	LGH 0602-IR 300 32	32	30	31	300	22	LG 0602L	40	⊗
Left Toolholder									
183030600	LGH 0602-IL 150 12	12	11	11,5	150	9	LG 0602R	16	⊗
183030700	LGH 0602-IL 150 16	16	15	15	150	11	LG 0602R	20	⊗
183030800	LGH 0602-IL 170 20	20	18	19	170	13	LG 0602R	25	⊗
183030900	LGH 0602-IL 200 25	25	23	24	200	17	LG 0602R	32	⊗
183031000	LGH 0602-IL 300 32	32	30	31	300	22	LG 0602R	40	⊗

⊗ Stock item | Produto de stock | Itens de stock ○ Available under request | Disponível sobre consulta | Disponible bajo consulta

LG-R

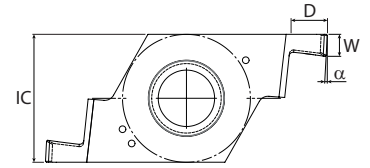

Order code Código	Reference Referência Referencia	Dimensions Dimensões Dimensiones (mm)				For circlip widht	Stock
		IC	α	W	D		PH7920
1130597G4	LG 0602R110	6,35	3	1,10	0,8	1,0	⊗
1130598G4	LG 0602R130	6,35	3	1,30	1,4	1,2	⊗
1130599G4	LG 0602R160	6,35	3	1,60	1,7	1,5	⊗
1130600G4	LG 0602R185	6,35	3	1,85	2,0	1,75	⊗
1130601G4	LG 0602R215	6,35	3	2,15	2,4	2,0	⊗
1130602G4	LG 0602R265	6,35	3	2,65	2,7	2,5	⊗
1130603G4	LG 0602R300	6,35	3	3,00	3,0	-	⊗
1130604G4	LG 0602R315	6,35	3	3,15	3,0	3,0	⊗

⊗ Stock item | Produto de stock | Itens de stock ○ Available under request | Disponível sobre consulta | Disponible bajo consulta

LG-L

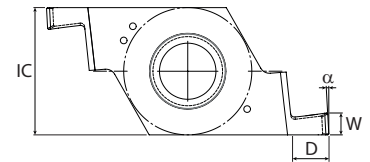
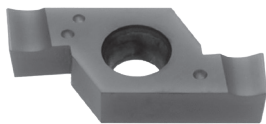

Order code Código	Reference Referência Referencia	Dimensions Dimensões Dimensiones (mm)				For circlip widht	Stock
		IC	α	W	D		PH7920
1130589G4	LG 0602L110	6,35	3	1,10	0,8	1,0	⊗
1130590G4	LG 0602L130	6,35	3	1,30	1,4	1,2	⊗
1130591G4	LG 0602L160	6,35	3	1,60	1,7	1,5	⊗
1130592G4	LG 0602L185	6,35	3	1,85	2	1,75	⊗
1130593G4	LG 0602L215	6,35	3	2,15	2,4	2,0	⊗
1130594G4	LG 0602L265	6,35	3	2,65	2,7	2,5	⊗
1130595G4	LG 0602L300	6,35	3	3,00	3	-	⊗
1130596G4	LG 0602L315	6,35	3	3,15	3	3,0	⊗

⊗ Stock item | Produto de stock | Itens de stock ○ Available under request | Disponível sobre consulta | Disponible bajo consulta

BLANKS



1 - Product Line

FG - Forming Grooving

2 - Product type

I - Insert

3 - Edge width (W)

13 - 13mm

16 - 16mm

20 - 20mm

32 - 32mm





1 - Product Line		2 - Cutting Width	
FG - Forming Grooving		H - Holder	
3 - Edge Width (Forming)			
		13 - 13 mm	
		16 - 16 mm	
		20 - 20 mm	
		32 - 32 mm (2 holes)	
4 - Toolholder Type (Forming)			
Type A	Type B	Type C	Type C
5 - Toolholder total length			
		125 - 125 mm	
		150 - 150 mm	
6 - Toolholder depth			
		10 - 10 mm	
		12 - 12 mm	
		14 - 14 mm	
		16 - 16 mm	
		20 - 20 mm	
7 - Insert height			
		10 - 10 mm	
		12 - 12 mm	
		14 - 14 mm	
		16 - 16 mm	
		25 - 25 mm	
8 - Insert relief angle			
		0°	
		5°	

FORMING GROOVING

BLANKS & TOOLHOLDERS

FGI

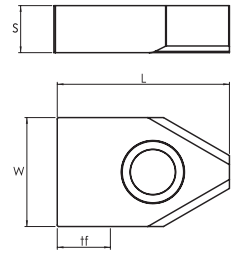
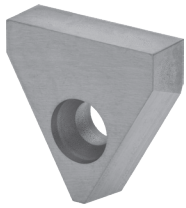

(1) Geometry code	(2) Grade code	UNC PH0930	Dimensions			
			W	S	L	tf
1130550	BLANK FGI 13	☉	13	5,35	20,70	6,00
1130551	BLANK FGI 16	☉	16	5,35	25,00	10,00
1130552	BLANK FGI 20	☉	20	6,35	20,70	7,00
1130615	BLANK FGI 20 L	☉	20	6,35	25,00	11,00

☉ Stock item | Produto de stock | Itens de stock ○ Available under request | Disponível sobre consulta | Disponible bajo consulta

Insert order code = (1) Geometry Code + (2) Grade Code

Type A

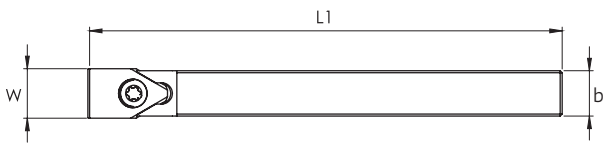

Type B

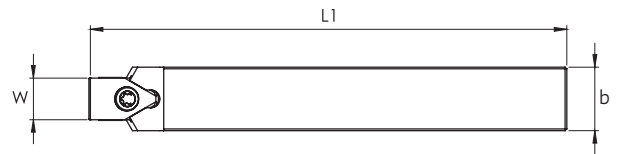

Type C



Type A|B|C



Order code		ISO Reference	Dimensions					Insert	Toolholder Type	Stock	
*a 0°	*a 5°		h	h1	b	L1	W			0°	5°
113056500	113055400	FGH 13-A 125 12.12 - 0°/5°	12	12	12	125	13	FGI 13	A	☉	☉
113056600	113055500	FGH 13-B 125 14.14 - 0°/5°	14	14	14	125	13	FGI 13	B	☉	☉
113058000	113058100	FGH 13-B 125 16.16-0°/5°	16	16	16	125	13	FGI 13	B	○	☉
113056700	113055600	FGH 13-C 125 10.10 - 0°/5°	10	10	10	125	13	FGI 13	C	○	☉
113056800	113055700	FGH 16-A 125 16.16 - 0°/5°	16	16	16	125	16	FGI 16	A	☉	☉
113056900	113055800	FGH 16-B 150 20.20 - 0°/5°	20	20	20	150	16	FGI 16	B	☉	☉
113057000	113055900	FGH 16-C 125 14.14 - 0°/5°	14	14	14	125	16	FGI 16	C	☉	☉
113057100	113056000	FGH 20-A 150 20.20 - 0°/5°	20	20	20	150	20	FGI 20	A	○	☉
113057200	113056100	FGH 20-C 125 16.16 - 0°/5°	16	16	16	125	20	FGI 20	C	○	☉
113061600	113061700	FGH 20L-A 150 20.20-0°/5°	20	20	20	150	20	FGI 20 L	A	☉	☉
113061800	113061900	FGH 20L-C 125 16.16-0°/5°	16	16	16	125	20	FGI 20 L	C	☉	☉

☉ Stock item | Produto de stock | Itens de stock ○ Available under request | Disponível sobre consulta | Disponible bajo consulta

FGI

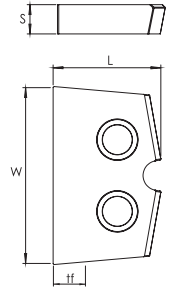
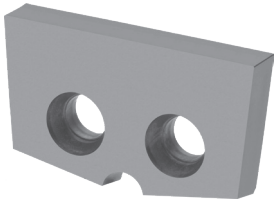

(1) Geometry code	ISO Reference	UNC PH0930	Dimensions (mm)			
			W	S	L	tf
1130553	BLANK FGI 32	18	32	5,00	19,80	7,00

⊗ Stock item | Produto de stock | Itens de stock

○ Available under request | Disponível sobre consulta | Disponible bajo consulta

Insert order code = (1) Geometry Code + (2) Grade Code

Type C

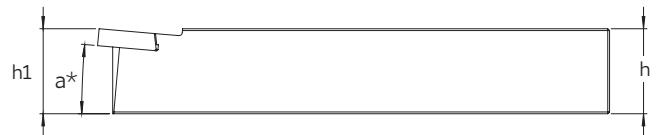
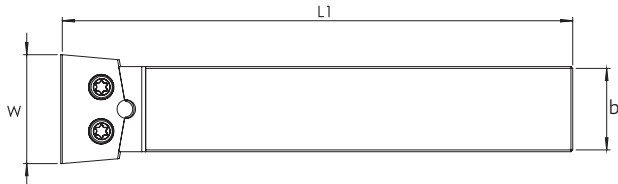

Order code		ISO Reference	Dimensions (mm)					Insert	Toolholder Type	Stock	
*a 0°	*a 5°		h	h1	b	L1	W			0°	5°
113057300	113056200	FGH 32-C 150 25.25 - 0°/5°	25	25	25	150	32	FGI 32	C	○	⊗

⊗ Stock item | Produto de stock | Itens de stock

○ Available under request | Disponível sobre consulta | Disponible bajo consulta

SCREWS & KEYS



Screws

Order code Código	Reference Referência Referencia	Stock
290074100	D0503000	<input checked="" type="checkbox"/>
290020700	D0603600	<input checked="" type="checkbox"/>
290062900	D0602200	<input checked="" type="checkbox"/>
290087400	D0602600	<input checked="" type="checkbox"/>
290087500	D0603100	<input checked="" type="checkbox"/>
290044800	P0260700	<input checked="" type="checkbox"/>
290044600	P5401390	<input checked="" type="checkbox"/>
290044900	P5401391	<input checked="" type="checkbox"/>

Keys

Order Code Código	Reference Referência Referencia	Stock
290011700	XT08	<input checked="" type="checkbox"/>
290013100	XT10	<input checked="" type="checkbox"/>

Stock item | Produto de stock | Itens de stock

Available under request | Disponível sobre consulta | Disponible bajo consulta

WRENCHES



Order code Código	Reference Referência Referencia	Stock
290021200	SS40	<input checked="" type="checkbox"/>
290021300	SS50	<input checked="" type="checkbox"/>

Order code Código	Reference Referência Referencia	Stock
290074400	LE05	<input checked="" type="checkbox"/>

Order code Código	Reference Referência Referencia	Stock
290079600	LE25-30	<input checked="" type="checkbox"/>

Stock item | Produto de stock | Itens de stock

Available under request | Disponível sobre consulta | Disponible bajo consulta

GROOVING & PARTING OFF GRADES | Graus para Sangramento | Calidades para Tronzado

	1	5	10	15	20	25	30	35	40	45	50		
P STEEL	PH5115			PH5125			PH5135			PHS135 <small>NEW</small>			CVD
	PH7920			PHP920 <small>NEW</small>			PHP930 <small>NEW</small>						
				PHS135 <small>NEW</small>									
				PH7920			PHP920 <small>NEW</small>			PHP930 <small>NEW</small>			
				PHS135 <small>NEW</small>									
				PH7920			PHP920 <small>NEW</small>			PHP930 <small>NEW</small>			
M STAINLESS SEEL				PHS135 <small>NEW</small>									PVD
				PH7920			PHP920 <small>NEW</small>			PHP930 <small>NEW</small>			
				PHS135 <small>NEW</small>									
				PH7920			PHP920 <small>NEW</small>			PHP930 <small>NEW</small>			
K CAST IRON	PH5705		PH5320		PH5135		PHS135 <small>NEW</small>					CVD	
	PH5705		PH5320		PH5135		PHS135 <small>NEW</small>						
	PH5705		PH5320		PH5135		PHS135 <small>NEW</small>						
	PH5705		PH5320		PH5135		PHS135 <small>NEW</small>						
N ALUMINIUM & NFM	PH0910										UNCOTED		
S HEAT RESISTENT / TITANIUM ALLOYS	PH7920			PHP920 <small>NEW</small>			PHP930 <small>NEW</small>						PVD
	PH7920			PHP920 <small>NEW</small>			PHP930 <small>NEW</small>						
	PH7920			PHP920 <small>NEW</small>			PHP930 <small>NEW</small>						

D

GROOVING & PARTING OFF

Grooving Plus

Grooving & Parting Off

SAL - Swiss Automatic Lathes

Light Grooving

Forming Grooving

Technical Data

GROOVING & PARTING OFF GRADES DESCRIPTION

Graus de Sangramento | Calidades para Tronzado

PVD GRADES

PH7920
 P10-P35
 M10-M25
 S10-S30

A hard carbide substrate coated with PVD coating. Suitable for machining under good conditions or lightly interrupted cuts.

PHP920 NEW
 P10-P35
 M10-M25
 S10-S30

A hard carbide insert coated with revolutionary PVD coating with great adhesion and smoothness. Recommended for machining under good conditions or lightly interrupted cuts at medium to high cutting speeds.

PHP930 NEW
 P20-P40
 M20-M40
 S15-S35

A tough carbide insert coated with revolutionary PVD coating with great adhesion and smoothness. Recommended for machining under lightly to highly interrupted cuts at low to medium cutting speeds.



CVD GRADES

PH5

A thick CVD coating with a smooth surface. Works great at medium temperatures.



PHS

PHS135 NEW
 P20-P40
 M15-M35
 K15-K30

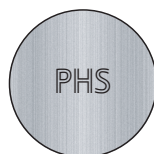

A tough substrate combined with a thin CVD coating with excellent thermal resistance and hardness at high temperature. Excellent solution for difficult operations at low velocities.

UNCOATED CARBIDE GRADE

PH0910
 N01-N20

Uncoated carbide with polished surface. 1st choice for machining aluminum alloys.

RECOMMENDED GRADES AND CUTTING SPEEDS (M/MIN)

Graus recomendados e velocidades de corte (m/min) | Calidades recomendadas y velocidades de corte (m/min)

ISO	Material	Grade fn (mm/r) HB (brinell)	CVD Coating				PVD Coating		
			← Wear Resistance				Toughness →		
			PH5115	PH5125	PH5135	PHS135	PH7920	PHP920	PHP930
P	Unalloyed steel	125-170	90-180	80-170	70-160	70-160	60-160	60-160	50-150
	Low-alloy steel	180-350	70-160	60-150	60-140	60-150	60-140	60-150	50-140
	High-alloy steel	200-325	50-150	40-140	40-130	40-140	50-130	50-140	40-130

ISO	Material	Grade fn (mm/r) HB (brinell)	CVD Coating	PVD Coating			
			← Wear Resistance			Toughness →	
			PHS135	PH7920	PHP920	PHP930	
M	SS - Ferritic / Martensitic	200-330	70-150	60-140	60-140	50-130	
	SS - Austenitic / Duplex	180-330	60-130	60-120	60-130	50-110	
	SS - Ferritic / Duplex	230-260	40-120	40-110	40-120	40-110	

ISO	Material	Grade fn (mm/r) HB (brinell)	CVD Coating				
			← Wear Resistance				Toughness →
			PH5705	PH5320	PH5115	PHS135	
K	Marble cast iron	130-230	100-220	90-210	90-200	80-170	
	Grey cast iron	180-220	100-200	90-190	80-180	70-150	
	Nodular cast iron	160-380	80-170	80-160	70-150	50-140	

ISO	Material	Grade fn (mm/r) HB (brinell)	Uncoated	
			PH0910	0.04 - 0.35
			N	Aluminium alloys

ISO	Material	Grade fn (mm/r) HB (brinell)	PVD Coating			
			← Wear Resistance			Toughness →
			PH7920	PHP920	PHP930	
S	Heat resistant super alloys (Iron base)	200-280	35-90	-	-	
	Heat resistant super alloys (Nickel base)	250-320	22-60	-	-	
	Heat resistant super alloys (Cobalt base)	200-320	30-90	30-90	20-80	

D

GROOVING & PARTING OFF

Grooving Plus

Grooving & Parting Off

SAL - Swiss Automatic lathes

Light Grooving

Forming Grooving

Technical Data